

parla\*

Collection 2023

**Parla** Collection



We are a third generation furniture company that is continuing a legacy, that goes 113 years back.

We know why we shine bright;

We are talented.

We love craft.

We are tech oriented.

We work hard.

We move fast.

We are agile.

We are fully collaborative.

We thrive on problem solving.

We are a dedicated project partner.

We achieve the dreams of our project partners and we shine brighter together!



**Hakan Öztunçman**  
*Owner Director*

**Burak Öztunçman**  
*Owner Director*

## **A message from the Light Bearers of Parla**

At Parla we are dedicated to chasing the light.

The blessed light of our grandfather who started this business as a loyal and respected furniture maker of The Ottoman Imperial Family.

The guiding light of our father, who taught us that we must take care of our customers and employees equally.

The sparkling light of our talented designers and hard-working factory workers.  
The light that we see in the faces of our delighted customers.

At Parla what uplifts our day is not just creating beautiful pieces of furniture but creating exceptional, outstanding outcomes and constantly raising the bar when it comes to quality and care.

This vision has made Parla shine bright as a reliable, resilient, and globally respected company that designs, crafts and manufactures pieces that stand the test of time.

Every day, we are ready than ever, to shine brighter.

We are here to pour in light to your projects, and shine together with you.



## Fusing Heritage, Crafts & Technology

Within our **15.000 sqm production facilities** consisting of workshops for wood, stainless steel and upholstery; we design and manufacture furniture using **hi-tech Italian machinery** alongside **experienced hand craftsman** who guide the process, and keep the heritage crafts element going.

Our **in house team of industrial designers & craftsmen** conceptualise, develop, design, and experiment with new ideas.

This brings about perfectly formed pieces of furniture that are fresh, cutting edge, technologically advanced and reflect Parla's heritage of traditional crafts in a contemporary manner.

We also welcome well known architects and designers to join us in creating new pieces, and run **'Product Creation Workshops'**.

In these workshops we marry the designer's expertise & innate talent with Parla's traditional & modern craft techniques, cutting edge technology and belief in **pushing boundaries**.

# A Sustainable Future

## **We really do care...**

About society, about the environment, about the economy.

We care about how we impact the environment. Nature is our mother!  
We care about looking after her, and leaving the right kind of legacy for future generations.

**We manufacture with sustainability in mind**, constantly developing ways to be more in harmony with nature when using resources such as wood, steel, aluminium, textiles and plastics.

**We care about people**; we care about women, we care about young people. And, like many companies in this sector it is 'work in progress'; everyday we are realising more about what we can do and how we can implement changes.

**Using the UN Sustainable Development Goals list as a yardstick**, we have set up an internal team that prods, probes and pushes the whole company to do better. Of course not all 17 of the goals are related to our business, but the

Goals that we feel we are really working on are:

#3 Good Health and Well-Being

#4 Quality Education

#5 Gender Equality

#6 Clean Water and Sanitation

#7 Affordable and Clean Energy

#8 Decent Work & Economic Growth

#9 Industry, Innovation & Infrastructure

#10 Reduced Inequalities

#12 Responsible Consumption and Production

#13 Climate Action

#15 Life on Land

#17 Partnership for the Goals

**Embedding these bigger picture Goals into our company culture is a journey** in which we find ourselves inspired to then tackle specific areas on a micro level.





## Our Practical Development Goals

**By the end of 2023**

- All adhesives and varnishes used will be water based.
- All our plastic packaging will be bio-degradable.
- 70% of our standard fabric options are manufactured in an environmentally conscious manner with Oeko-Tex, Greenguard and/or EU Eco Label certificates.
- 50% of our standard outdoor fabrics are recycled.

**By 2025**

- 80% of the products in our collection will use recycled fabrics.
- At least 20% of our Collection's product families will be crafted from sustainable, recycled and/or bio compostible materials.

**By 2027**

- We will have put a water recycling system in place for the whole factory and all drinking water will be supplied from these units.
- Our factory will reduce its water consumption by 80%.

**By 2030**

- 50% of our Collection's product families will be crafted from sustainable, recycled and/or bio compostible materials.
- Our production facilities will be using a renewable energy source.

Find out more about our sustainability goals at [parladesign.com/sustainability](http://parladesign.com/sustainability)

## Our Design Ethos

### FUSION

In each of our designs we fuse influences from our rich cultural heritage and the artisanal. We apply this to design; to form, to technique and to use of materials.

### HARMONY

Every piece of furniture we design, craft and manufacture is a true reflection of our client's vision and sits in harmony with the environment it is being placed in.

### RESPECT TO RESOURCES

In both design and manufacturing we set limits to how we apply our vast pool of resources and knowledge so that we are not exorbitant with the use of time, materials and labour.

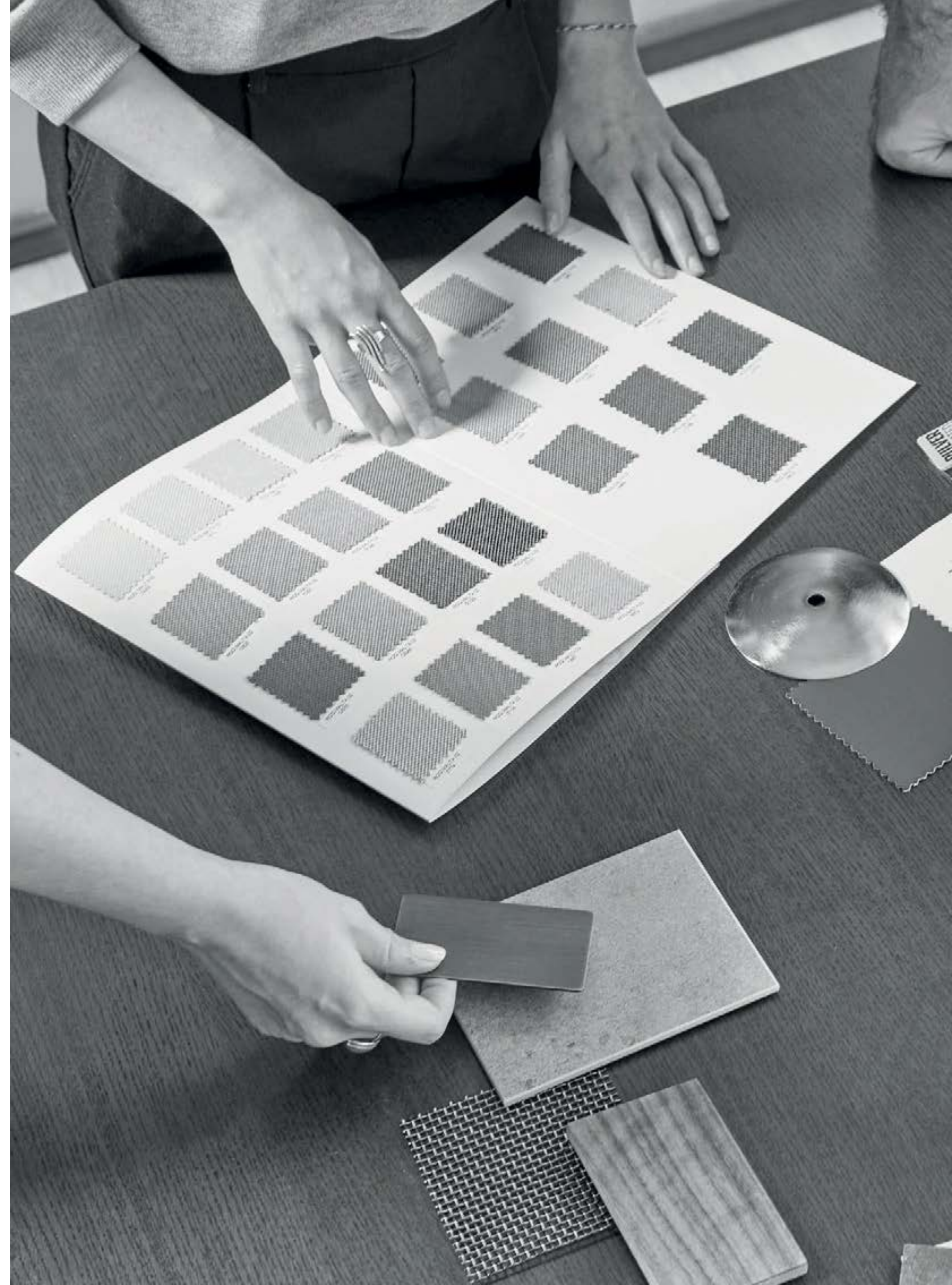



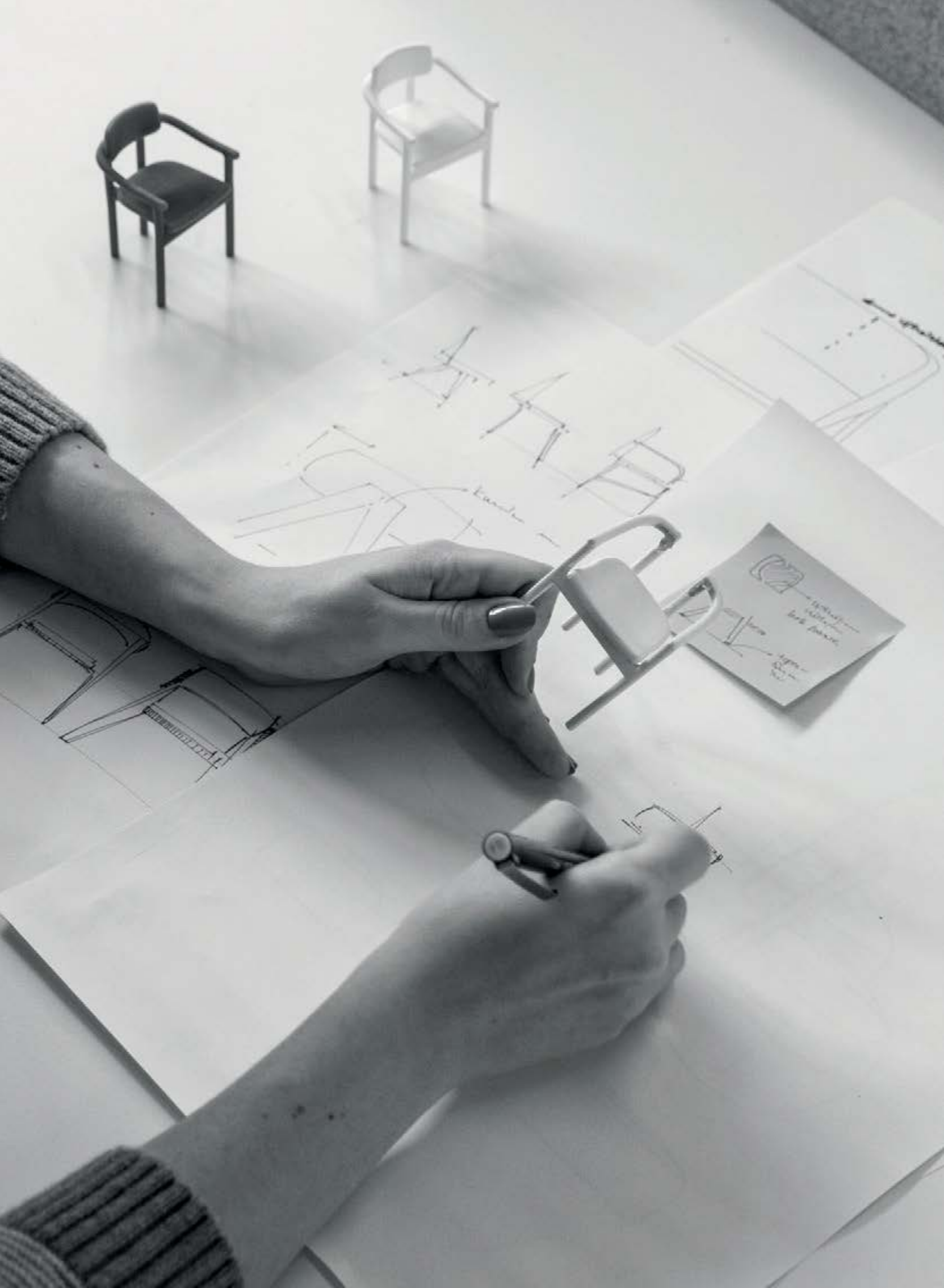

# Designers





## Betül İnci

Head of Parla Design Team, Betül started exploring ways of expression at a young age. Alongside her ultimate role model, her father, who was a teacher, sketching, designing and producing craft during her childhood years led to her building a professional career as a designer. She studied Industrial Product Design at Istanbul Technical University and Linneaus University in Sweden; following on from that she also added furniture design training at The Florence Institute of Design to her education.

From the Aegean region in Western Turkey to metropolitan Istanbul, Scandinavia to Mediterranean Italy, her multicultural education is very much reflected in her designs. She likes to use forms born from minimalism, add to that the inclusion of bold colours, she combines simplicity with extravagance in a poetic manner.

Betul has been working for Parla for 10 years and during this time she has participated in many projects spanning from New York to Dubai as Product Designer and Project Manager.

Betul's design Nigiri Chair has won the Good Design Award 2021 from The Chicago Athenaeum: Museum of Architecture and Design.



## Aysel İlişik

Former Project Manager and Senior Designer of Parla, Aysel studied Industrial Design at Anadolu University and started her career as a product designer in Istanbul.

As a highly experienced furniture designer and business development enthusiast; Aysel is focused on building and maintaining Parla's exceptional customer relationships within the A&D community.

Specialized in Hospitality interiors with a deep understanding of high-end and bespoke furniture; she is currently working as the Head of Designer Relations.



## Deniz Albayrak

Born in Bulgaria, Deniz studied Industrial Design at Anadolu University and moved to Istanbul after his graduation.

Starting his career as a product designer in Parla, he is currently one of the co-founders of Parla Studio, while continuing his development in management roles in the company.

His Professional development has taken him from being a Project Manager to a Pre-Contract Manager to currently working for Parla as a Senior Projects Manager, living and working from Parla's London Office.



## Erden Dereli

After graduating from Anadolu University; Erden completed his design internship at d'Arc Studio Roma. Moving forward to his professional career in Parla; he worked 4 years as an Industrial Designer and 3 years as a Production Planning Manager, where he experienced various projects of mid to large scale all over the world for contract products.

Being one of the founders of Parla Studio, Erden currently continues his works specialising on production processes. His designs are mainly focused on materials, functionalities, manufacturability and R&D industry.



## Berrak İlkcan Şener

Born in Fethiye, studied in Eskisehir and based as a designer in Istanbul, Berrak was awarded by BigSee for her design of the Rimo Armchair in 2022. Berrak completed her Bachelor's degree in Industrial Design at Anadolu University. During her education, she participated in a student exchange program at HAWK Hochschule University, Hildesheim, Germany.

Moving forward she based her designs on these influences, combining them with her unique ideas. Aiming for timeless, clean and functional product designs.

Berrak creates durable and user friendly products which are also timeless in their look.



## Seda Yetkiner

Seda studied Industrial Design at Anadolu University and made a quick start to her career at the same time at Yakamoz Glass designing niche objects and installations. During her years there, she found the opportunity to practise and become a master at hot glass production, which then became her passion – creating glass objects is now her most favoured hobby. She joined Parla Design Studio in 2019, widening her experience with new materials.

Her approach to design is reflected in furniture through bold shapes, that are warm, familiar, grounded and functional whilst embellished with elegant details.



## Enis Altinkaynak

Enis was always fond of exploring his imagination via his drawings.

After graduating from Anadolu University, he proceeded on to a master's degree at Marmara University where he continues his research on the effects of modern technologies within the area of product design, while lecturing upcoming Industrial Designers at Beykent University. While enjoying every design ideology, Enis actually prefers to follow a totalitarian approach when it comes to design.

Always trying to reach excellence, he is fond of learning about materials and production processes in order to master them.



## Yasemin Derici Çeri

During her studies of Industrial Design in Izmir; she and 4 of her friends set up a brand that created handmade concrete trays & objects. Following their passion for design and identity, they took part in the Milan Design Market, as part of Milan Design Week, and launched their product line there.

Focusing on product design, photoshoot styling, trend research, social media managing, visual, creative, and digital media creation for marketing, Yasemin continues her career as an Art Director.



## Burcu Özdamar

After graduating from Middle East Technical University, Department of Industrial Design, she started working at Parla.

Working in cooperation with experienced craftsmen in the workshop, she learned the nature of the materials closely. The combination of different textures, geometric games and East-West identity synthesis can be easily experienced in her products. The designer, who cares about understanding the needs of both the user and space, stands out with her customizable products.

Burcu is currently working as a product manager and continues her design projects personally.



## Umut Kargınoğlu

Born in Gaziantep, Umut studied Industrial Product Design at Istanbul Technical University and settled in Istanbul to base his design career in the city. During his internships, he gained experience on ideation and production methods for office, restaurant and urban furniture design.

Highly skilled in Product Design, Model Making, Branding & Identity, Concept Generation accompanied with a strong engineering experience for professional production techniques, Umut is currently working as a Product Design and Development Specialist.



## Buket Hoşcan Bazman

Buket Hoşcan Bazman was born in Izmir, Turkey, in 1989. Graduated from the Işık University and after few years of working in the industry, she founded her own design brand under the name "Marbleous" in 2015, which produces marble detailed furniture and objects. In 2018, Buket set up her own design studio.

Currently, she is working on contemporary collectible pieces.

Buket focuses on traditional craftsmanship with natural materials. Each piece is made by craftsmen based in Turkey.



## David Fox

David Fox Design, is a multi-award winning industrial and product design studio with awards from Red Dot, Good Design Award to FX product designer of the Year in 2009.

Their spectrum of product designs range from furniture, to bathroom basins, faucets, cabinet hardware, fabric and carpet design.

Their international client base covers: Belgium, Turkey, UK, Italy, Czech republic, Canada, Poland & Spain.



## Esin Sözer Kalender

Arketipo Design was founded by Murad Denizaltı , Müge Hansoy Kınacı and Esin Sözer Kalender in 1994. For the past 27 years, they have worked on various Hotel, Spa, Shopping Center, Office and Residential projects; achieving successful results in each.

They have achieved over 80 projects in their country of headquarters, Turkey and have also achieved 100 completed projects in various countries such as Dubai, Germany, Russia, Libya, Kazakhstan and Ukraine.



## Klan Studio

Founded by Eşref Akın Oral and Işık Görgün Oral, Klan Studio is a design studio working primarily on furniture, yacht and machinery design sectors.

They like to define themselves as “modernists” prioritizing the efficiency of casuality and dominance of clever design.

What they want to underline, is always superiority of consistency. Naturally, making sure they always deliver the “right design” for every brief they come across.



## Kilit Taşı Design Studio

Kilit Taşı is a design studio based in Istanbul which provides industrial design, design management, strategic design consultancy services to companies from different sectors. Co-founder Kunter Sekercioglu values cultural traits, craftsmanship, history and the details of daily life as points of inspiration for his designs.

He believes that quality in design is defined by distinction, innovation, enjoyment, practicality and affordability. In order to achieve this, he chooses to participate actively in every stage of the process, starting from the initial sketches all the way to the launch of the production.





# Chairs



## Fau A Chair



### Designer Kilit Taşı

Frame: Solid ash structure  
Seat & Back: Upholstered seat  
Finish: Available in multiple stain colours

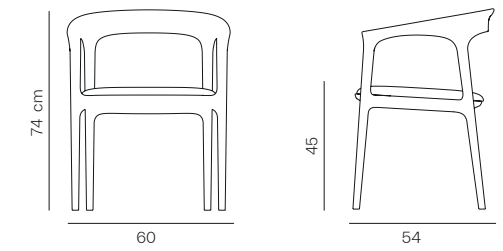

#### Dimensions

W 60 D 54 H 74    Seat height: 46 cm



Good Design® Award winner from  
The Chicago Athenaeum: Museum of  
Architecture and Design

## Nigiri Chair



### Designer Betül İnci

Frame: Solid ash structure  
Seat & Back: Upholstered seat and back  
Finish: Available in multiple stain colours

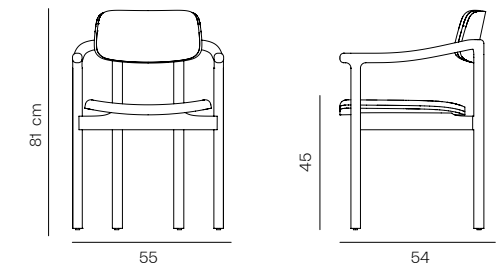

#### Dimensions

W 55 D 54 H 81    Seat height: 45 cm





Monochrome Galataport - Istanbul, Turkey

## Gala V Chair



### Designer Burcu Özdamar

Frame: Ash veneer Plywood back and solid ash legs  
Seat & Back: Upholstered seat and back  
Finish: Available in multiple stain colours

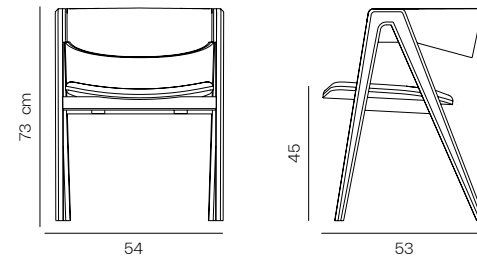

#### Dimensions

W 54 D 53 H 73    Seat height: 45 cm

## Venus A Chair



### Designer Betül İnci

Frame: Solid beech structure  
Seat & Back: Upholstered seat and back  
Finish: Available in multiple stain colours

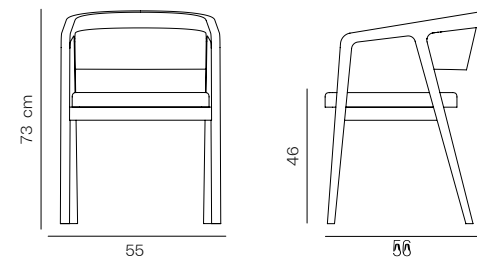

#### Dimensions

W 55 D 56 H 73    Seat height: 46 cm

## Venus Chair



### Designer Betül İnci

Frame: Solid beech structure  
Seat & Back: Upholstered seat and back  
Finish: Available in multiple stain colours

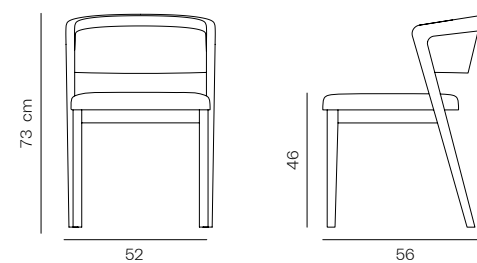

#### Dimensions

W 52 D 56 H 73    Seat height: 46 cm







Holiday Inn Heathrow - London, UK

## Arven Chair



### Designer Burcu Özdamar

Frame: Plywood back and solid beech legs, metal, brass or stainless steel arms (with powder coated metal and coloured steel options)

Seat & Back: Upholstered seat and back

Finish: Available in multiple stain colours, arms available in Antique Brass, RAL or steel colours

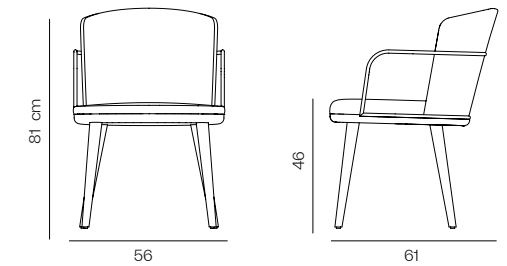

#### Dimensions

W 56 D 61 H 81      Seat height: 46 cm

## Arven L Chair



### Designer Burcu Özdamar

Frame: Plywood back and solid beech legs

Seat & Back: Upholstered seat and back

Finish: Available in multiple stain colours

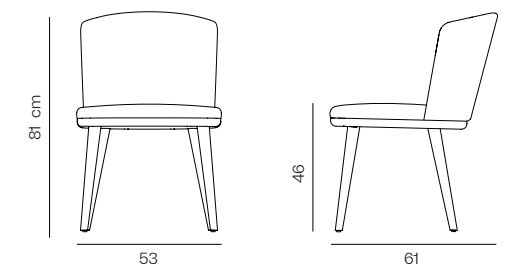

#### Dimensions

W 53 D 61 H 81      Seat height: 46 cm

## Oyster Chair



### Designer Enis Altinkaynak

Frame: Plywood back and solid ash legs  
Seat & Back: Upholstered seat and back  
Finish: Available in multiple stain colours

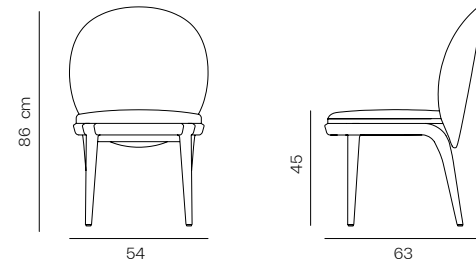

#### Dimensions

W 54 D 63 H 86    Seat height: 45 cm

## Oyster W Chair



### Designer Enis Altinkaynak

Frame: Plywood back and metal or stainless steel legs  
(with powder coated metal and coloured steel options)  
Seat & Back: Upholstered seat and back  
Finish: Available in RAL or steel colours

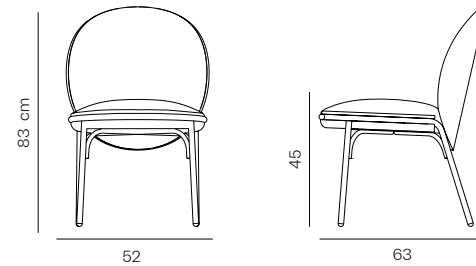

#### Dimensions

W 52 D 63 H 83    Seat height: 45 cm

## Oyster WA Chair



### Designer Enis Altinkaynak

Frame: Plywood back and metal or stainless steel legs  
(with powder coated metal and coloured steel options)  
Seat & Back: Upholstered seat and back  
Finish: Available in RAL or steel colours

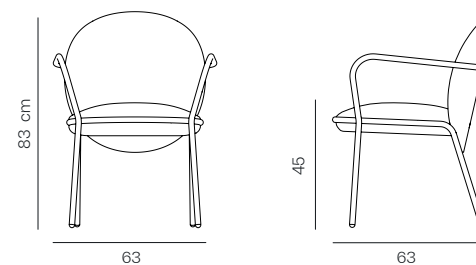

#### Dimensions

W 63 D 63 H 83    Seat height: 45 cm





## Meru Chair



**Designer** Burcu Özdamar

Frame: Powder coated metal structure with moulded polyurethane back  
 Seat & Back: Upholstered seat and back  
 Finish: Available in RAL colours

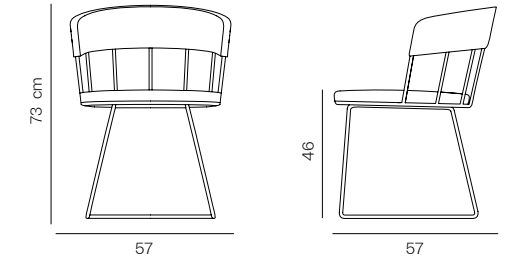

**Dimensions**  
 W 57 D 57 H 73    Seat height: 46 cm

## Meru L Chair



**Designer** Burcu Özdamar

Frame: Powder coated metal structure with moulded polyurethane back and solid beech structure  
 Seat & Back: Upholstered seat and back  
 Finish: Available in multiple stain colours, back available in RAL colours

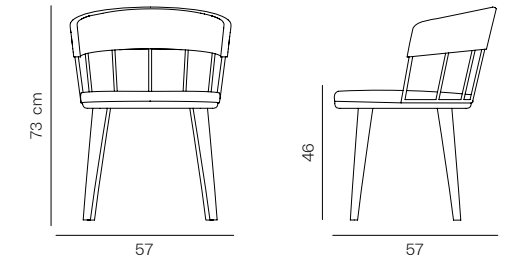

**Dimensions**  
 W 57 D 57 H 73    Seat height: 46 cm

## Kybele WF Chair



**Designer** Erden Dereli

Frame: Solid ash structure  
 Seat & Back: Upholstered seat, back and arms  
 Finish: Available in multiple stain colours

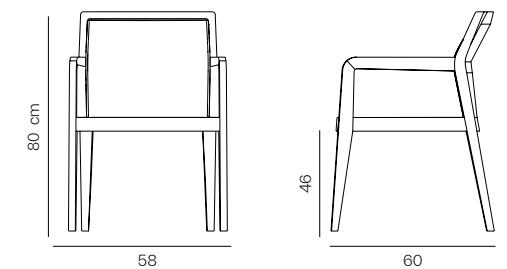

**Dimensions**  
 W 58 D 60 H 80    Seat height: 46 cm

## Chia Chair



### Designer Betül İnci

Frame: Plywood back and metal or stainless steel legs  
(with powder coated metal and coloured steel options)  
Seat & Back: Upholstered seat and back  
Finish: Available in RAL or steel colours

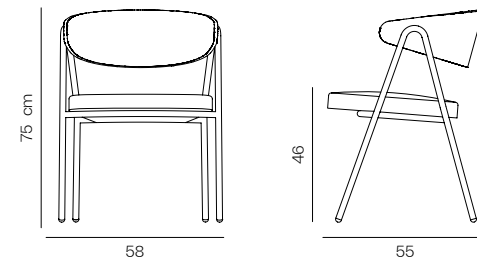

#### Dimensions

W 58 D 55 H 75    Seat height: 46 cm

## Rimo Chair



### Designer Berrak İlkcan Şener

Frame: Plywood back and metal or stainless steel legs  
(with powder coated metal and coloured steel options)  
Seat & Back: Upholstered seat and back  
Finish: Available in RAL or steel colours

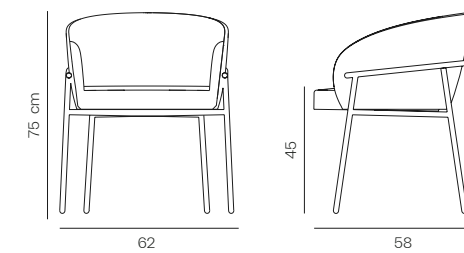

#### Dimensions

W 62 D 58 H 75    Seat height: 45 cm





Pınar Hotel - Balıkesir, Turkey

## Olive Chair



### Designer Betül İnci

Frame: Moulded polyurethane back and solid beech structure  
 Seat & Back: Upholstered seat and back  
 Finish: Available in multiple stain colours

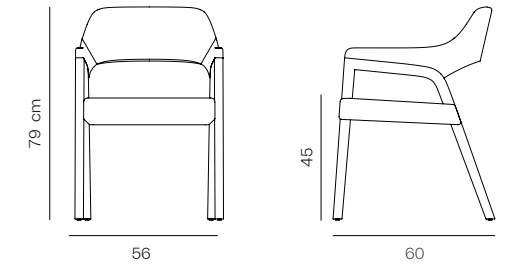

#### Dimensions

W 56 D 60 H 79    Seat height: 45 cm

## Atlas A Chair



### Designer Betül İnci

Frame: Plywood back and solid beech legs  
 Seat & Back: Upholstered seat and back  
 Finish: Available in multiple stain colours

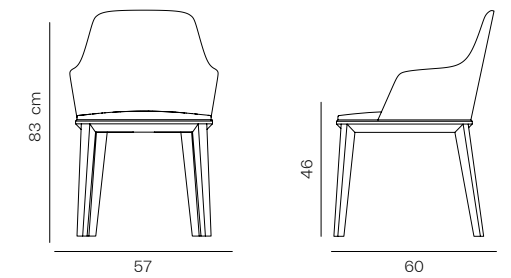

#### Dimensions

W 57 D 60 H 83    Seat height: 46 cm

## Atlas Chair



### Designer Betül İnci

Frame: Plywood back and solid beech legs  
 Seat & Back: Upholstered seat and back  
 Finish: Available in multiple stain colours

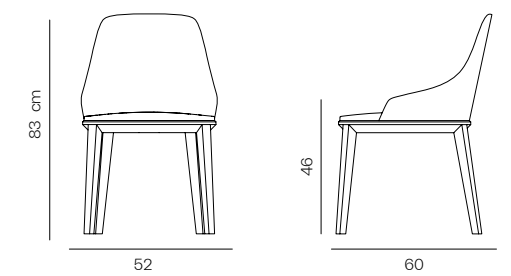

#### Dimensions

W 52 D 60 H 83    Seat height: 46 cm





## Mate XL Chair



**Designer** Aysel İlişik

Frame: Beech plywood back and seat, solid beech structure  
Seat & Back: Upholstered seat and back  
Finish: Available in multiple stain colours

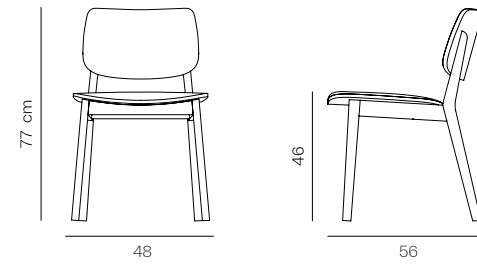

**Dimensions**

W 48 D 56 H 77    Seat height: 46 cm

## Mate XL V Chair



**Designer** Aysel İlişik

Frame: Beech plywood back and seat, solid beech structure  
Finish: Available in multiple stain colours

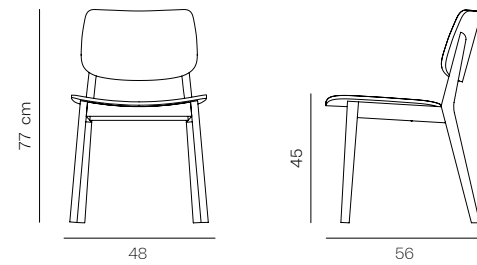

**Dimensions**

W 48 D 56 H 77    Seat height: 45 cm

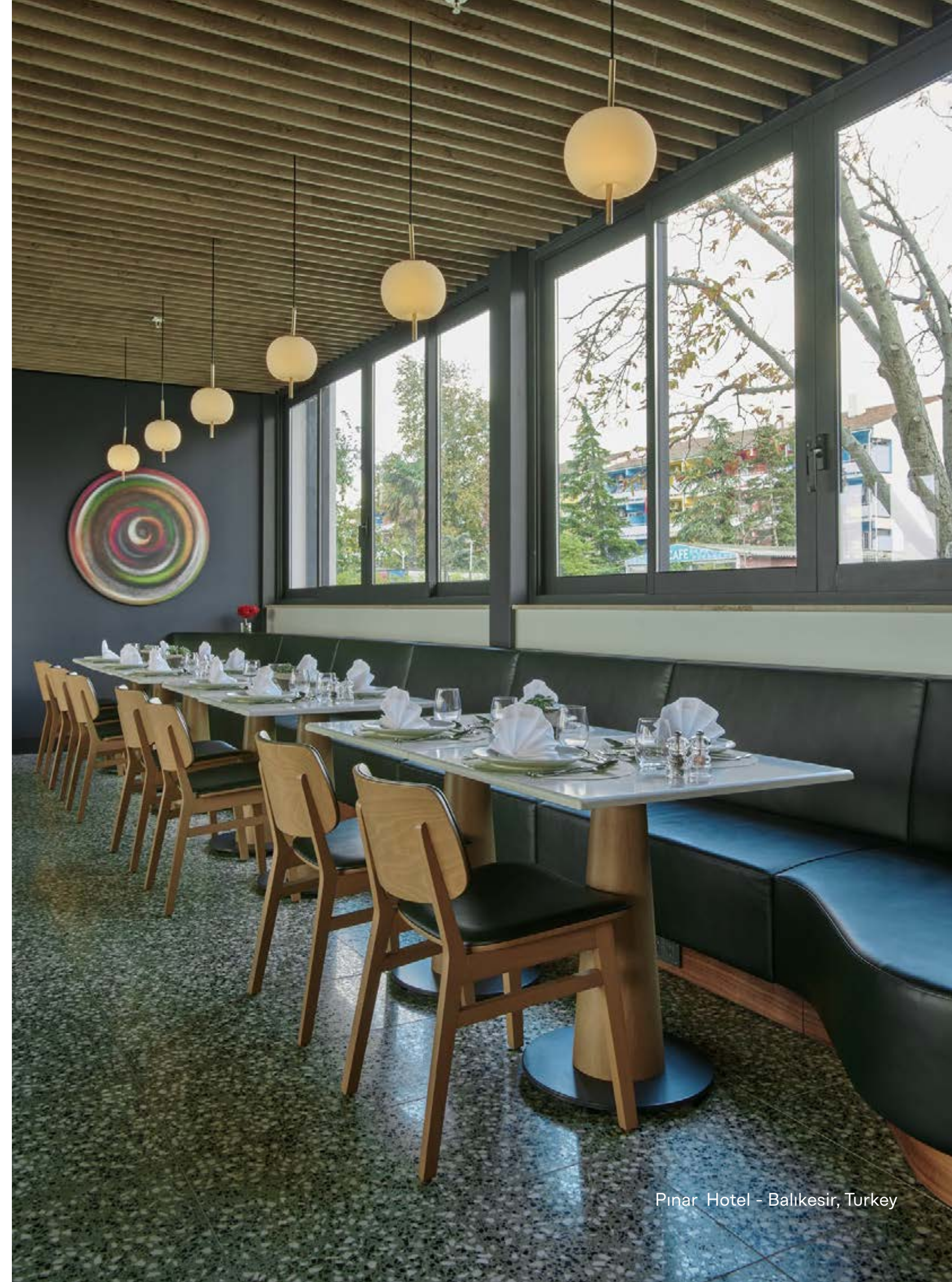



Liman Restaurant - Istanbul, Turkey

## Ren Chair



### Designer Betül İnci

Frame: Plywood back with solid beech legs  
Seat & Back: Upholstered seat and back  
Finish: Available in multiple stain colours

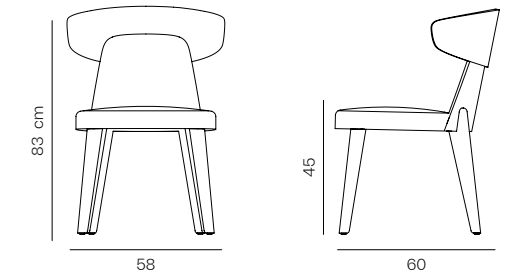

#### Dimensions

W 58 D 60 H 83    Seat height: 45 cm

## Ren P Chair



### Designer Betül İnci

Frame: Plywood back and solid beech legs  
Seat & Back: Upholstered seat and back  
Finish: Available in multiple stain colours

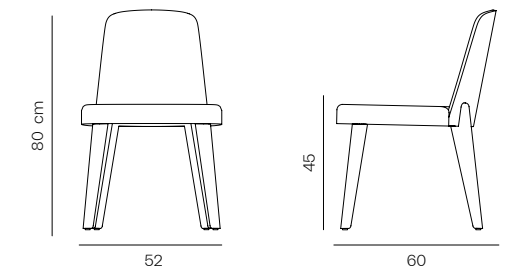

#### Dimensions

W 52 D 60 H 80    Seat height: 45 cm

## Luna A Chair



### Designer Betül İnci

Frame: Solid beech structure  
Seat: Upholstered seat  
Finish: Available in multiple stain colours

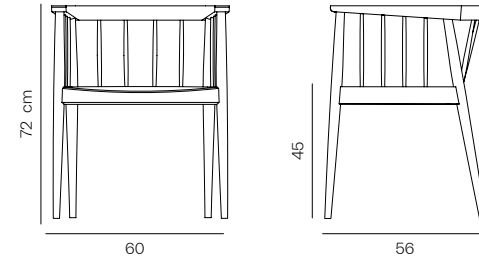

**Dimensions**  
W 60 D 56 H 72    Seat height: 45 cm

## Remus Chair



### Designer David Fox

Frame: Moulded polyurethane body with solid beech legs  
Seat & Back: Upholstered seat and back  
Finish: Available in multiple stain colours

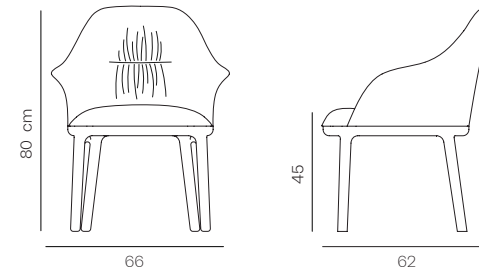

**Dimensions**  
W 66 D 62 H 80    Seat height: 45 cm

## Remus S Chair



### Designer David Fox

Frame: Moulded polyurethane body, solid beech legs  
Seat & Back: Upholstered seat and back  
Finish: Available in multiple stain colours

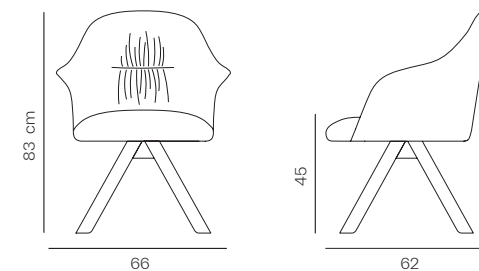

**Dimensions**  
W 66 D 62 H 83    Seat height: 45 cm





Meatco Steakhouse - Istanbul, Turkey

### Sabien Chair



**Designer David Fox**

Frame: Plywood back and solid beech legs  
 Seat & Back: Upholstered quilted seat and back  
 Finish: Available in multiple stain colours

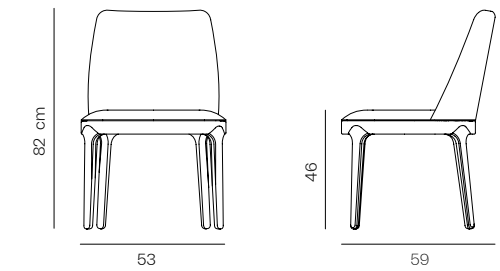

**Dimensions**  
**W 53 D 59 H 82**    Seat height: 46 cm

### Sabien A Chair



**Designer David Fox**

Frame: Plywood back and solid beech legs  
 Seat & Back: Upholstered quilted seat and back  
 Finish: Available in multiple stain colours

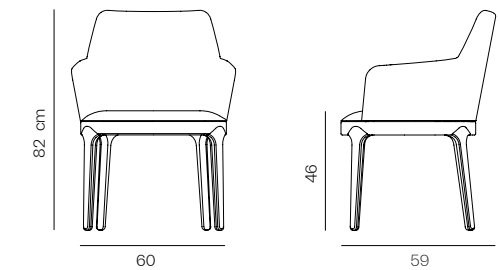

**Dimensions**  
**W 60 D 59 H 82**    Seat height: 46 cm

### Mod Chair



**Designer Betül İnci**

Frame: Moulded polyurethane body with solid beech legs  
 Seat & Back: Upholstered seat and back  
 Finish: Available in multiple stain colours

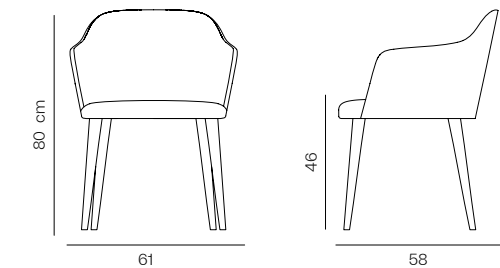

**Dimensions**  
**W 61 D 58 H 80**    Seat height: 46 cm

## Stella Chair



### Designer Betül İnci

Frame: Plywood back and solid beech legs  
Seat & Back: Upholstered seat and back  
Finish: Available in multiple stain colours

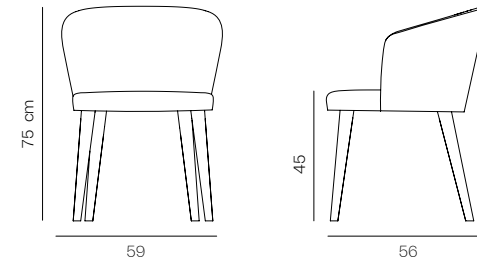

#### Dimensions

W 59 D 56 H 75    Seat height: 45 cm

## Stella V Chair



### Designer Betül İnci

Frame: Oak veneer plywood back and solid beech legs  
Seat & Back: Upholstered seat and inner back  
Finish: Available in multiple stain colours

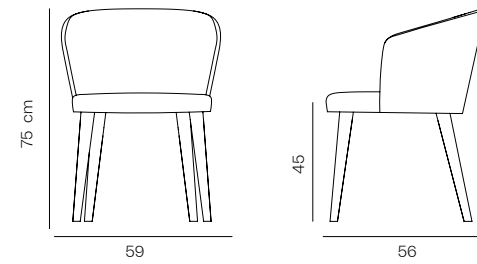

#### Dimensions

W 59 D 56 H 75    Seat height: 45 cm

## Stella W Chair



### Designer Betül İnci

Frame: Plywood back and powder coated metal leg  
Seat & Back: Upholstered seat and back  
Finish: Available in RAL colours

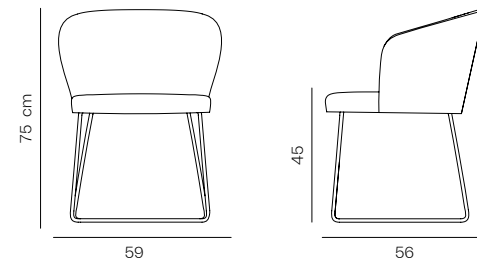

#### Dimensions

W 59 D 56 H 75    Seat height: 45 cm



Haugen - London, UK





Maxx Royal Belek Golf Resort - Antalya, Turkey

### Mod W Chair



#### Designer Betül İnci

Frame: Moulded polyurethane body with powder coated metal leg  
 Seat & Back: Upholstered seat and back  
 Finish: Available in RAL colours

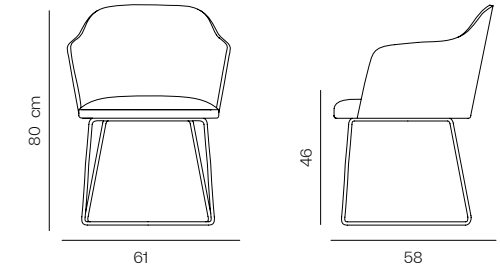

**Dimensions**  
 W 61 D 58 H 80    Seat height: 46 cm

### Mod S Chair



#### Designer Betül İnci

Frame: Moulded polyurathane body with die-cast aluminium swivel base  
 Seat & Back: Upholstered seat and back  
 Finish: Available polished chrome and black

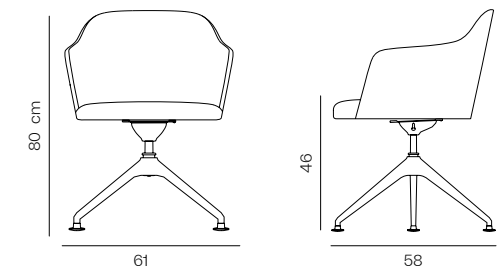

**Dimensions**  
 W 61 D 58 H 80    Seat height: 46 cm

### Mod RS Chair



#### Designer Betül İnci

Frame: Moulded polyurathane body with die-cast aluminium swivel base with castors  
 Seat & Back: Upholstered seat and back  
 Finish: Available polished chrome and black

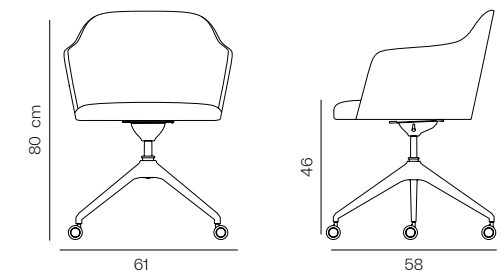

**Dimensions**  
 W 61 D 58 H 80    Seat height: 46 cm





# Armchairs



Painting by Ahmet Çerkez

## Hug Armchair

**Designer** Betül İnci

Frame: Plywood and solid beech structure, oak wood base  
Seat & Back: Upholstered seat and back  
Finish: Available in multiple stain colours

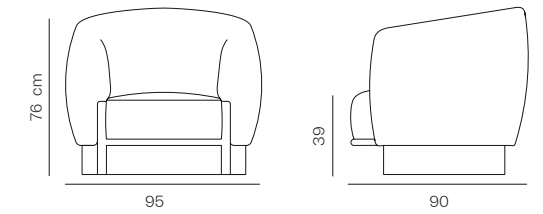

**Dimensions**

W 95 D 90 H 76    Seat height: 39 cm

## Moose Armchair

**Designer** Deniz Albayrak

Frame: Solid ash back structure, ash veneer base  
Seat & Back: Upholstered seat  
Finish: Available in multiple stain colours

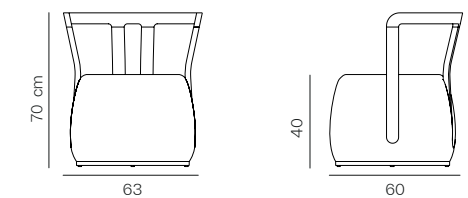

**Dimensions**

W 63 D 60 H 70    Seat height: 40 cm

## Rimo Armchair



**Designer** Berrak İlkcan Şener

Frame: Moulded polyurethane body and metal or stainless steel legs (with powder coated metal and coloured steel options)  
Seat & Back: Upholstered seat and back  
Finish: Available in RAL or steel colours

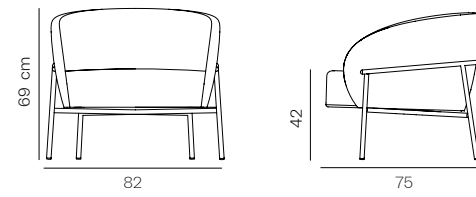

**Dimensions**

W 82 D 75 H 69    Seat height: 42 cm

## Oyster W Armchair



**Designer** Enis Altinkaynak

Frame: Plywood back and metal or stainless steel legs (with powder coated metal and coloured steel options)  
Seat & Back: Upholstered seat and back  
Finish: Available in RAL or steel colours

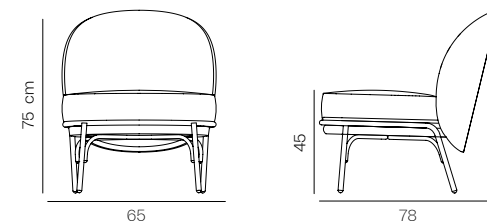

**Dimensions**

W 65 D 78 H 75    Seat height: 45 cm





## Xaylon Armchair



**Designer** David Fox

Frame: Moulded polyurethane body and solid beech legs  
 Seat & Back: Upholstered seat and back  
 Finish: Available in multiple stain colours

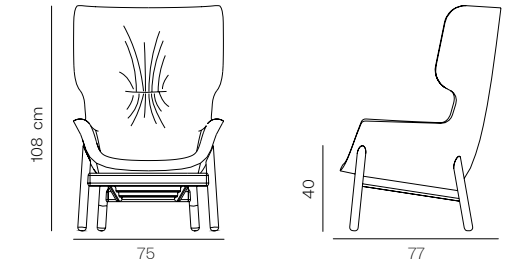

**Dimensions**

**W 75 D 77 H 108**    Seat height: 40 cm

## Xaylon W Armchair



**Designer** David Fox

Frame: Moulded polyurethane body and metal or stainless steel legs (with powder coated and coloured steel options)  
 Seat & Back: Upholstered seat and back  
 Finish: Available in RAL or steel colours

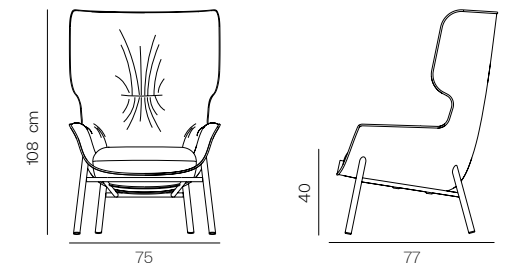

**Dimensions**

**W 75 D 77 H 108**    Seat height: 40 cm

## Eve Wing Back Armchair



**Designer** Erden Dereli

Frame: Plywood and solid beech structure and solid beech legs  
 Seat & Back: Upholstered seat and back  
 Finish: Available in multiple stain colours

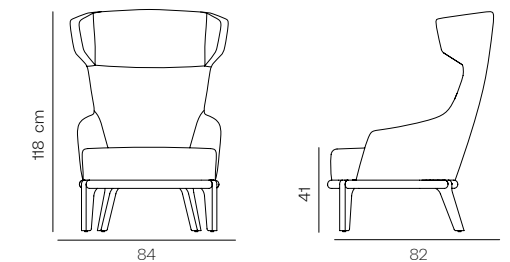

**Dimensions**

**W 84 D 82 H 118**    Seat height: 41 cm

## Remus Armchair



**Designer** David Fox

Frame: Moulded polyurethane body, solid beech legs  
Seat & Back: Upholstered seat and back  
Finish: Available in multiple stain colours

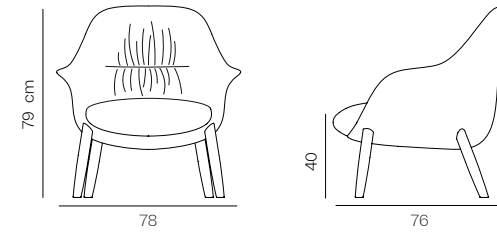

**Dimensions**

W 78 D 76 H 79    Seat height: 40 cm

## Atlas Armchair



**Designer** Betül İnci

Frame: Plywood and solid beech structure, solid beech legs  
Seat & Back: Upholstered seat and back  
Finish: Available in multiple stain colours

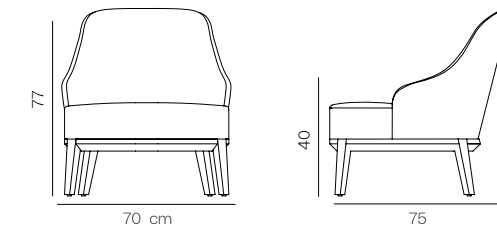

**Dimensions**

W 70 D 75 H 77    Seat height: 42 cm

## Atlas V Armchair



**Designer** Betül İnci

Frame: Plywood and solid beech structure, solid beech legs  
Seat & Back: Upholstered seat and back  
Finish: Available in multiple stain colours

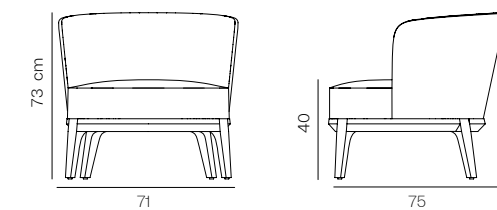

**Dimensions**

W 71 D 75 H 73    Seat height: 40 cm



Ruya Restaurant - London, UK

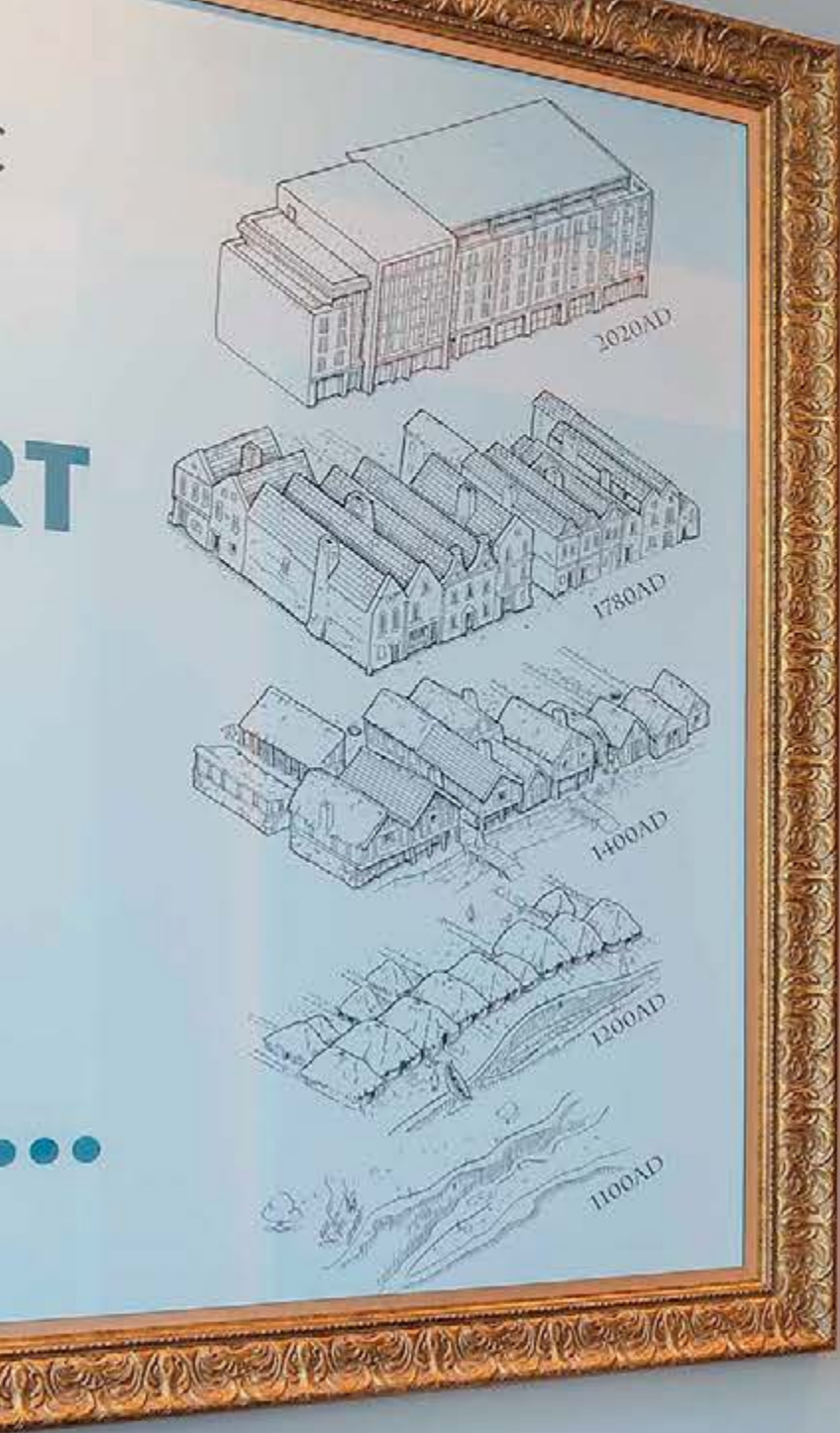

10<sup>th</sup> CENTURY



11<sup>th</sup> - 12<sup>th</sup> CENTURY



10<sup>th</sup> - 11<sup>th</sup> CENTURY



10<sup>th</sup> - 13<sup>th</sup> CENTURY



10<sup>th</sup> - 12<sup>th</sup> CENTURY



12<sup>th</sup> CENTURY



12<sup>th</sup> CENTURY



12<sup>th</sup> - 13<sup>th</sup> CENTURY



12<sup>th</sup> CENTURY



12<sup>th</sup> CENTURY



12<sup>th</sup> CENTURY



12<sup>th</sup> CENTURY



12<sup>th</sup> CENTURY



12<sup>th</sup> CENTURY



12<sup>th</sup> CENTURY





Orelle - Birmingham, UK

## Padova Armchair



**Designer** Betül İnci

Frame: Plywood structure, oak veneer plywood back and base (with 360° swivel base option)  
 Seat & Back: Upholstered seat and inner back  
 Finish: Available in multiple stain colours

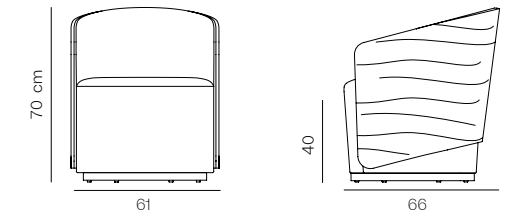

**Dimensions**  
**W 61 D 66 H 70**    Seat height: 40 cm

## Padova U Armchair



**Designer** Betül İnci

Frame: Moulded polyurethane back and plywood structure with natural oak veneer base (with 360° swivel base option)  
 Seat & Back: Upholstered seat and back  
 Finish: Available in multiple stain colors

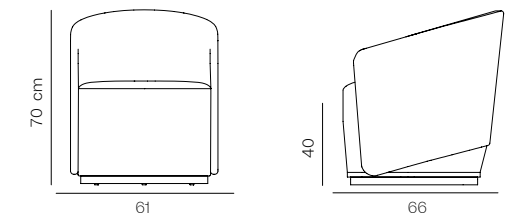

**Dimensions**  
**W 61 D 66 H 70**    Seat height: 40 cm

## Bloom Club Armchair



**Designer** Betül İnci

Frame: Plywood and solid beech structure (with 360° swivel base option)  
 Seat & Back: Upholstered seat and back cushions

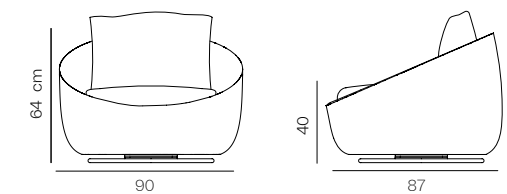

**Dimensions**  
**W 90 D 87 H 64**    Seat height: 40 cm

## Net Armchair



### Designer Betül İnci

Frame: Plywood and solid beech structure  
Seat & Back: Upholstered seat and inner back, woven banana fiber back  
Finish: Available in multiple stain colours

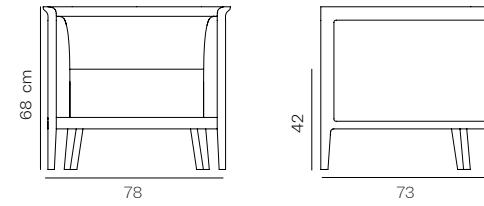

#### Dimensions

W 78 D 73 H 68    Seat height: 42 cm

## Net WF Armchair



### Designer Betül İnci

Frame: Plywood and solid beech structure  
Seat & Back: Upholstered seat, inner and outer back  
Finish: Available in multiple stain colours

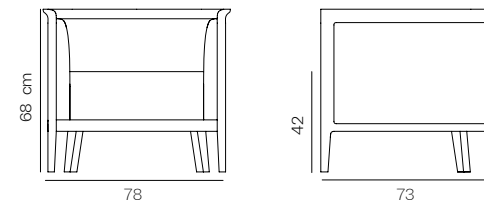

#### Dimensions

W 78 D 73 H 68    Seat height: 42 cm

## Goba Armchair



### Designer Esin Sözer Kalender

Frame: Solid beech structure  
Seat & Back: Upholstered seat and back cushions  
Finish: Available in multiple stain colours

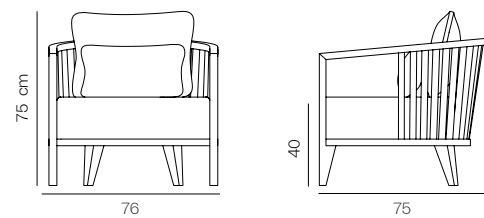

#### Dimensions

W 76 D 75 H 75    Seat height: 40 cm







Roberto's Restaurant Dubai - Dubai, UAE

## Milla Armchair

**Designer** Parla Studio

Frame: Plywood and solid beech structure, solid beech legs  
 Seat & Back: Upholstered seat and back  
 Finish: Available in multiple stain colours

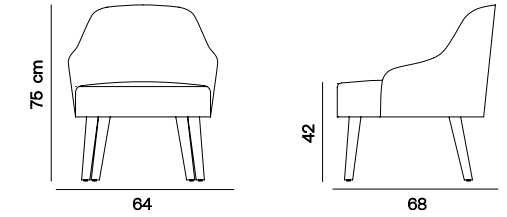

**Dimensions**  
**W 64 D 68 H 75**    Seat height: 42 cm

## Luce Armchair

**Designer** Betül İnci

Frame: Plywood and solid beech structure, powder coated metal legs  
 Seat & Back: Upholstered seat and back  
 Finish: Available in RAL colours

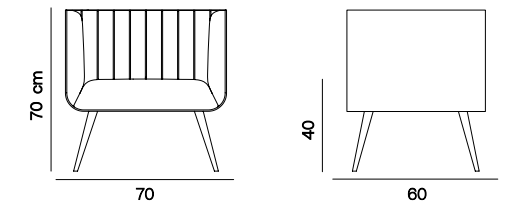

**Dimensions**  
**W 70 D 60 H 70**    Seat height: 40 cm

## Estival Armchair

**Designer** Parla Studio

Frame: Plywood and solid beech structure, powder coated metal base  
 Seat & Back: Upholstered seat, back and cushions  
 Finish: Available in RAL colours

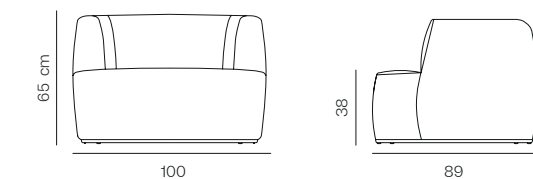

**Dimensions**  
**W 100 D 89 H 65**    Seat height: 38 cm



# Stools & Poufs

## Remus Pouf

**Designer** David Fox

Frame: Plywood structure and solid beech legs  
Seat: Upholstered seat  
Finish: Available in multiple stain colours

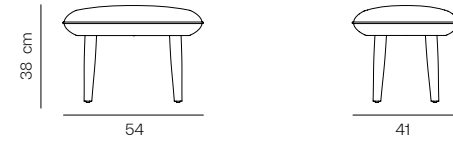

**Dimensions**  
W 54 D 41 H 38 cm

## Luce Stool

**Designer** Betül İnci

Frame: Beech veneer plywood and powder coated metal legs  
Seat: Upholstered seat  
Finish: Available in RAL colours and seat base available in multiple stain colours

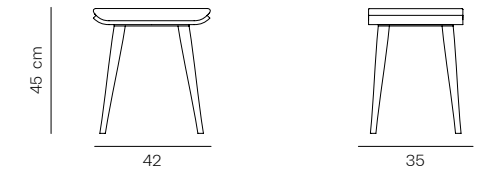

**Dimensions**  
W 42 D 35 H 45 cm

## Atlas Pouf

**Designer** Betül İnci

Frame: Plywood structure, solid beech legs  
Seat: Upholstered seat  
Finish: Available in multiple stain colours

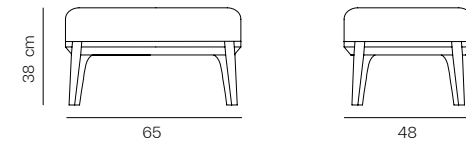

**Dimensions**  
W 65 D 48 H 38 cm

## Luce Foot Stool

**Designer** Betül İnci

Frame: Beech veneer plywood and powder coated metal legs  
Seat: Upholstered seat  
Finish: Available in RAL colours and seat base available in multiple stain colours

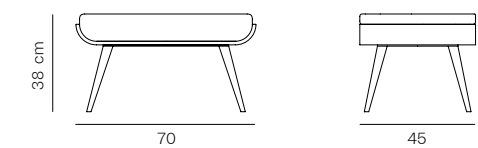

**Dimensions**  
W 70 D 45 H 38 cm

## London Pouf

**Designer** Burcu Özdamar

Frame: Plywood and solid beech structure, wood veneer base and metal or stainless steel legs (with powder coated metal and coloured steel options)  
Seat: Upholstered seat  
Finish: Base available in natural walnut or oak veneer with multiple stain colours, legs available in RAL or steel colours

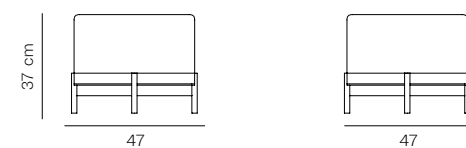

**Dimensions**  
W 47 D 47 H 37 cm

## Rocks Pouf

**Designer** Deniz Albayrak

Frame: Plywood structure  
Seat: Upholstered seat

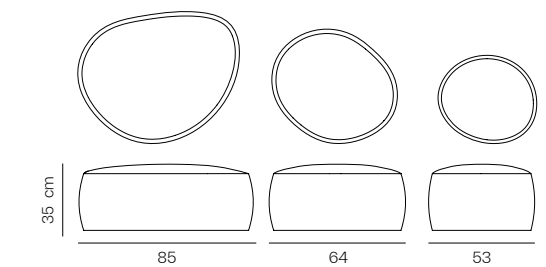

**Dimensions**  
W 85 D 64 H 35 cm big  
W 64 D 50 H 35 cm medium  
W 53 D 46 H 35 cm small





# Bar Stools



## Nigiri Bar Stool

**Designer** Betül İnci

Frame: Solid ash structure  
 Seat & Back: Upholstered seat and back  
 Finish: Available in multiple stain colours  
 \*Available in Counter Height

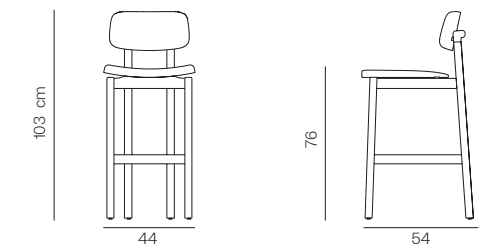

**Dimensions**

W 44 D 54 H 103    Seat height: 76 cm

## Oyster Bar Stool

**Designer** Enis Altınkaynak

Frame: Plywood back and metal or stainless steel legs (with powder coated metal and coloured steel options)  
 Seat & Back: Upholstered seat and back  
 Finish: Available in RAL or steel colours  
 \*Available in Counter Height

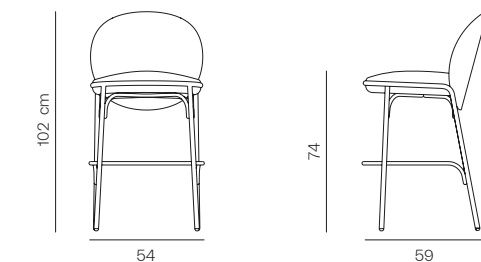

**Dimensions**

W 54 D 59 H 102    Seat height: 74 cm



## Arven Bar Stool

Designer Burcu Özdamar

Frame: Plywood back and solid beech legs, brass, metal or stainless steel arm & footrest (with powder coated metal and coloured steel options)

Seat & Back: Upholstered seat and back

Finish: Available in multiple stain colours, arm & footrest are available in Antique Brass, RAL or steel colours

\*Available in Counter Height

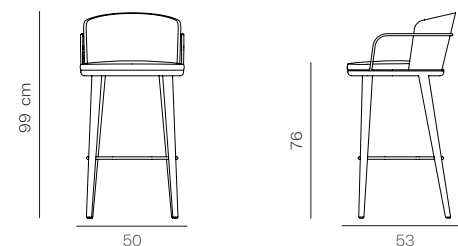

### Dimensions

W 50 D 53 H 99    Seat height: 76 cm



## Arven L Bar Stool

Designer Burcu Özdamar

Frame: Plywood back and solid beech legs, brass, metal or stainless steel footrest (with powder coated metal and coloured steel options)

Seat & Back: Upholstered seat and back

Finish: Available in multiple stain colours, footrest is available in Antique Brass, RAL or steel colours

\*Available in Counter Height

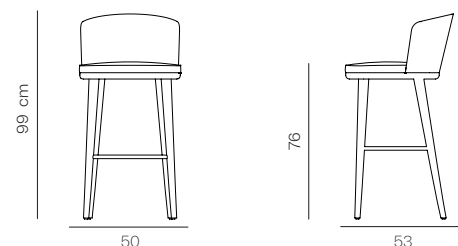

### Dimensions

W 50 D 53 H 99    Seat height: 76 cm



L'Esquisse Hotel & Spa Colmar - Colmar, France







Holiday Inn Heathrow - London, UK



## Meru Bar Stool

**Designer** Burcu Özdamar

Frame: Moulded polyurethane back with powder coated metal structure  
 Seat & Back: Upholstered seat and back  
 Finish: Available in RAL colours

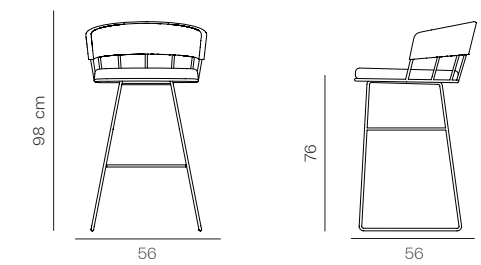

### Dimensions

W 56 D 56 H 98    Seat height: 76 cm



## Meru L Bar Stool

**Designer** Burcu Özdamar

Frame: Moulded polyurethane back with powder coated metal structure, footrest and solid beech legs  
 Seat & Back: Upholstered seat and back  
 Finish: Available in multiple stain colors, back and footrest are available in RAL colours  
 \*Available in Counter Height

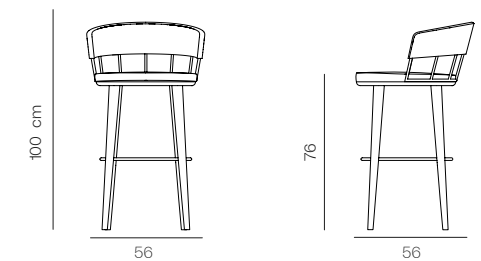

### Dimensions

W 56 D 56 H 100    Seat height: 76 cm

## Flento Bar Stool

**Designers** Berrak İlkcan Şener & Yasemin Derici Çeri

Frame: Solid ash and coloured stainless steel legs, coloured stainless steel footrest  
Seat: Upholstered genuine leather seat  
Finish: Available in steel colours, legs available in multiple stain colours, top available in Relax Series genuine leather colours

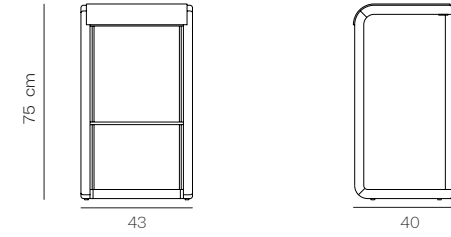

### Dimensions

W 43 D 40 H 75    Seat height: 75 cm

## Luce Bar Stool

**Designer** Betül İnci

Frame: Plywood shell and powder coated metal legs  
Seat: Upholstered seat  
Finish: Available in RAL colours

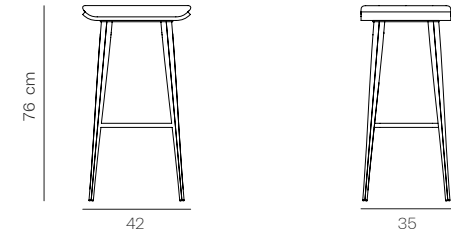

### Dimensions

W 42 D 35 H 76    Seat height: 76 cm

## Chia Bar Stool

**Designer** Betül İnci

Frame: Plywood back and metal or stainless steel legs (with powder coated metal and coloured steel options)  
Seat & Back: Upholstered seat and back  
Finish: Available in RAL or steel colours  
\*Available in Counter Height

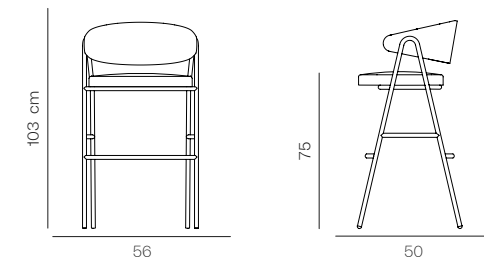

### Dimensions

W 56 D 50 H 103    Seat height: 75 cm





Private Office Project- Istanbul, Turkey

## Sabien A Bar Stool

**Designer David Fox**

Frame: Plywood back and solid beech legs  
 Seat & Back: Upholstered quilted seat and back  
 Finish: Available in multiple stain colours

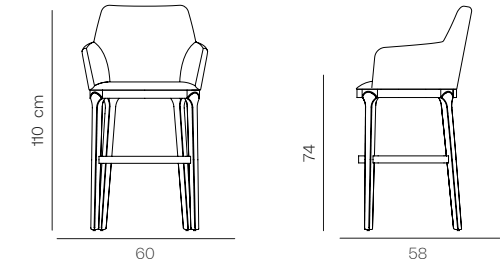

**Dimensions**

**W 60 D 58 H 110**    Seat height: 74 cm

## Stella Bar Stool

**Designer Betül İnci**

Finish: Plywood back and solid beech legs, brass, metal or stainless steel footrest (with powder coated metal and coloured steel options)  
 Seat & Back: Upholstered seat and back  
 Finish: Available in multiple stain colours, footrest available in Antique Brass, RAL or steel colours

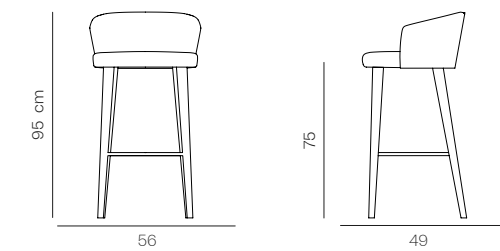

**Dimensions**

**W 56 D 49 H 95**    Seat height: 75 cm

## Venus Bar Stool

**Designer Betül İnci**

Frame: Solid beech structure  
 Seat & Back: Upholstered seat  
 Finish: Available in multiple stain colours  
 \*Available in Counter Height

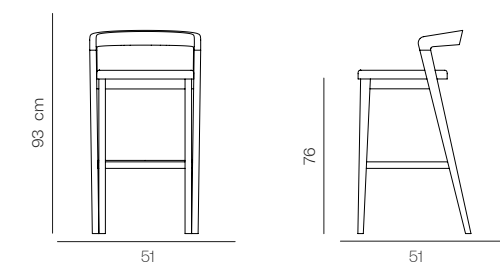

**Dimensions**

**W 51 D 51 H 93**    Seat height: 76 cm



## Mate Bar Stool

**Designer** Aysel İlişik

Frame: Beech plywood back and solid beech structure  
Seat & Back: Upholstered seat and back  
Finish: Available in multiple stain colours  
\*Available in Counter Height

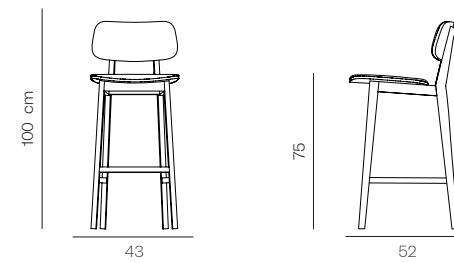

**Dimensions**

W 43 D 52 H 100    Seat height: 75 cm



## Bloom Bar Stool

**Designer** Betül İnci

Frame: Plywood structure, powder coated metal leg  
Seat & Back: Upholstered seat and back  
Finish: Available in RAL colours  
\*Available in Counter Height

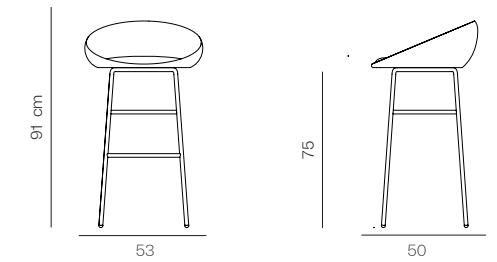

**Dimensions**

W 53 D 50 H 91    Seat height: 75 cm



## Mate V Bar Stool

**Designer** Aysel İlişik

Frame: Beech plywood back and seat, solid beech structure  
Finish: Available in multiple stain colours  
\*Available in Counter Height

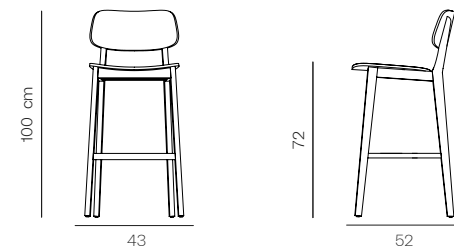

**Dimensions**

W 43 D 52 H 100    Seat height: 72 cm



## Bloom WA Bar Stool

**Designer** Betül İnci

Frame: Plywood structure and solid beech legs, brass, metal or stainless steel footrest (with powder coated metal and coloured steel options)  
Seat & Back: Upholstered seat and back  
Finish: Available in multiple stain colours, footrest is available in Antique Brass, RAL or steel colours

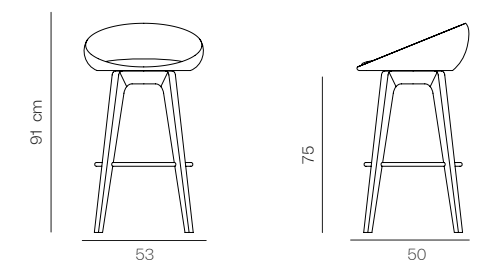

**Dimensions**

W 53 D 50 H 91    Seat height: 75 cm





# Tables

## Tofu Table

**Designer Seda Yetkiner**

Top: Marble top available in Alexander Black, Bruno Perla, Carrara, Emperador Mocca Marbles or Travertine Stone  
Leg: Oak veneer base with coloured stainless steel trim base  
Finish: Available in multiple stain colours, steel base is available in steel colours

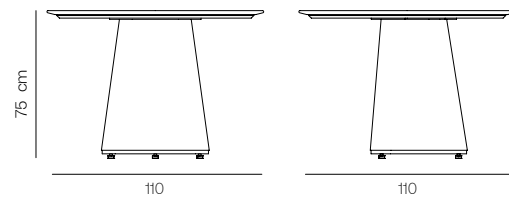

**Dimensions**  
Dia 110 H 75 cm

## Roll B Table

**Designer Parla Studio**

Top: Oak veneer on birch plywood table top  
Leg: Powder coated metal leg and base  
Finish: Top available in multiple stain colours, leg available in RAL colours

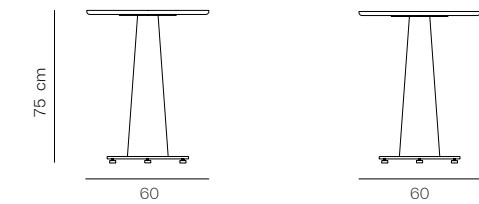

**Dimensions**  
Dia 60 H 75 cm

## Tofu V Table

**Designer Seda Yetkiner**

Top: Oak veneer table top with solid wood edge  
Leg: Oak veneer base with coloured stainless steel trim base  
Finish: Top and leg available in multiple stain colors, coloured stainless steel trim available in coloured steel colors

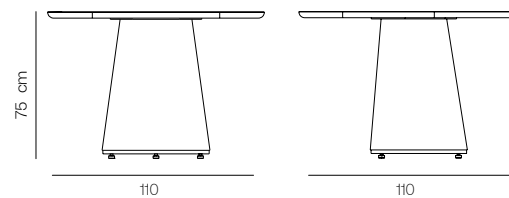

**Dimensions**  
Dia 110 H 75 cm

## Tria Table

**Designer Betül İnci**

Top: Natural oak veneer  
Leg: Solid limba legs  
Finish: Available in multiple stain colours



**Dimensions**  
W 220 D 100 H 75 cm







# Coffee Tables

## Blossom Coffee Table



**Designer** Betül İnci

Top: Cast glass top  
Leg: Coloured stainless steel leg and terrazzo base  
Finish: Leg available in steel colours

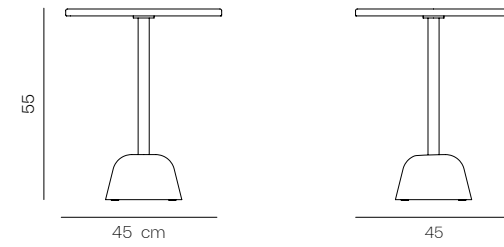

**Dimensions**  
Dia 45 H 55 cm

## Tofu Coffee Table



**Designer** Seda Yetkiner

Top: Clear glass top with coloured stainless steel joinery details, glass available in Extra Clear, Bronze and Smoked Glass options  
Leg: Oak veneer with coloured stainless steel base trim  
Finish: Leg available in multiple stain colours, steel base trim and joinery detail available in steel colours

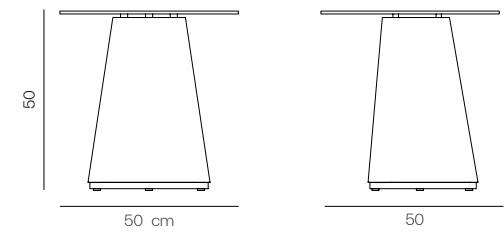

**Dimensions**  
Dia 50 H 50 cm

## Tofu V Coffee Table



**Designer** Seda Yetkiner

Top: Oak veneer on birch plywood table top  
Leg: Oak veneer with coloured stainless steel base trim  
Finish: Available in multiple stain colours, steel base available in steel colours

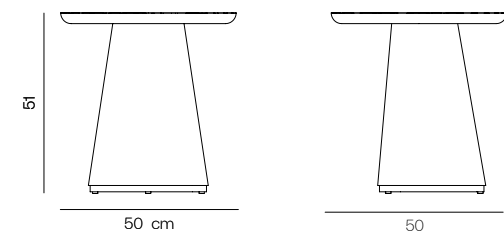

**Dimensions**  
Dia 50 H 51 cm



## Mandala Coffee Table



**Designer** Burcu Özdamar

Top: Tempered glass top available in Extra Clear, Bronze and Smoked glass colours  
 Leg: Powder coated metal leg  
 Finish: Leg available in RAL colours

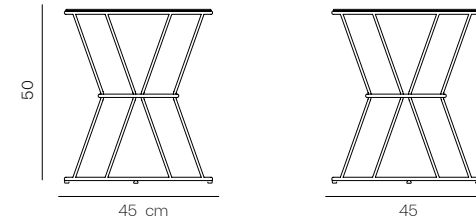

**Dimensions**  
 Dia 45 H 50 cm

## Jane M Coffee Table



**Designer** Parla Studio

Top: Marble top available in Alexander Black, Bruno Perla, Carrara or Emparador Mocca marble or Travertine Stone  
 Leg: Powder coated metal leg  
 Finish: Available in RAL colours

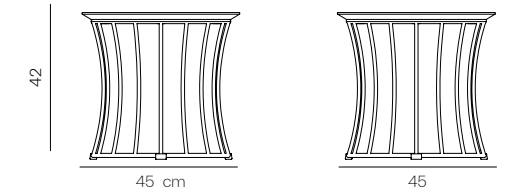

**Dimensions**  
 Dia 45 H 42 cm

## Mandala V Coffee Table



**Designer** Burcu Özdamar

Top: Wood veneer top available in natural walnut veneer or oak veneer with multiple stain colours  
 Leg: Powder coated metal leg  
 Finish: Leg available in RAL colours

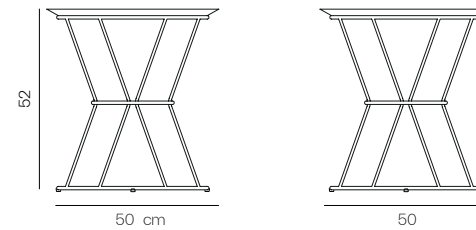

**Dimensions**  
 Dia 50 H 52 cm

## Miller Coffee Table



**Designer** Parla Studio

Top: Wood veneer top available in natural walnut veneer or oak veneer with multiple stain colours  
 Leg: Powder coated metal leg  
 Finish: Leg available in RAL colours

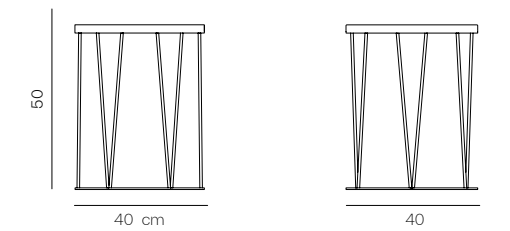

**Dimensions**  
 Dia 40 H 50 cm

## Mandala M Coffee Table



**Designer** Burcu Özdamar

Top: Marble top available in Alexander Black, Bruno Perla, Carrara or Emparador Mocca marble or Travertine Stone  
 Leg: Powder coated metal leg  
 Finish: Leg available in RAL colours

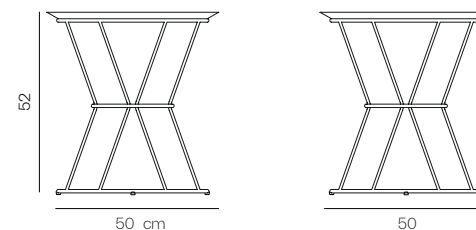

**Dimensions**  
 Dia 50 H 52 cm

## Platy Coffee Table



**Designer** Parla Studio

Top: Wood veneer on birch plywood, available in natural walnut veneer or oak veneer with multiple stain colours  
 Leg: Powder coated metal leg  
 Finish: Leg available in RAL colours

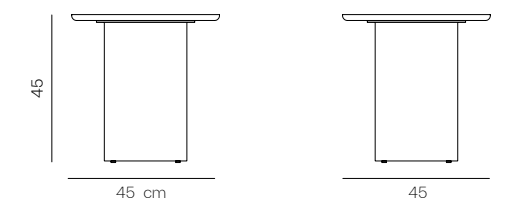

**Dimensions**  
 Dia 45 H 45 cm



## Flento Side Table

**Designers** Berrak İlkcan Şener & Yasemin Derici Çeri

Top: Upholstered genuine leather top  
 Leg: Solid ash structure and with coloured stainless steel holder  
 Finish: Available in steel colours, legs available in multiple stain colours, top available in Relax Series genuine leather colours

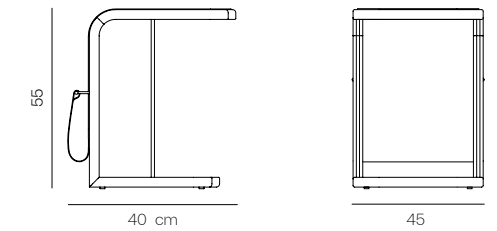

**Dimensions**  
**W 40 D 45 H 55 cm**

## Mawe Low Coffee Table

**Designer** Yasemin Derici Çeri

Top: Glass top available in Extra Clear, Bronze and Smoked glass colours  
 Leg: Marble base available in Alexander Black marble or Travertine Stone

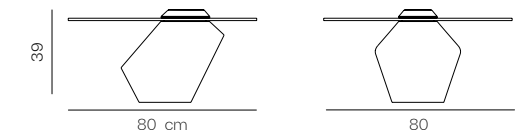

**Dimensions**  
**Dia 80 H 39 cm**

## Mawe Coffee Table

**Designer** Yasemin Derici Çeri

Top: Glass top available in Extra Clear, Bronze and Smoked glass colours  
 Leg: Marble base available in Alexander Black marble or Travertine Stone

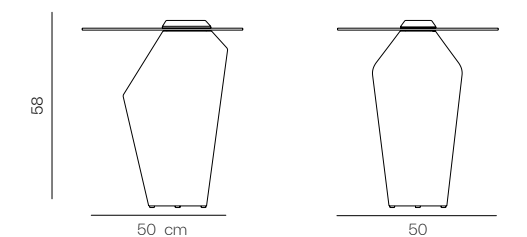

**Dimensions**  
**Dia 50 H 58 cm**

## Bone Coffee Table



**Designer** Umut Karginoğlu

Top: Marble top available in Alexander Black, Bruno Perla, Carrara or Emparador Mocca marble or Travertine Stone  
Leg: Solid beech legs  
Finish: Available in multiple stain colours

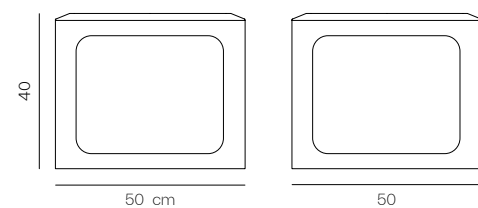

**Dimensions**  
W 50 D 50 H 40 cm

## Bone Mid Coffee Table



**Designer** Umut Karginoğlu

Top: Marble top available in Alexander Black, Bruno Perla, Carrara or Emparador Mocca marble or Travertine Stone  
Leg: Solid beech legs  
Finish: Available in multiple stain colours

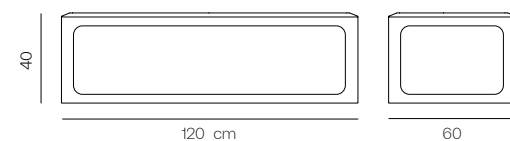

**Dimensions**  
W 120 D 60 H 40 cm

## London High Coffee Table



**Designer** Burcu Özdamar

Top: Wood veneer top available in natural walnut veneer or oak veneer with multiple stain colours  
Leg: Metal or stainless steel legs (with powder coated metal and coloured steel options)  
Finish: Available in multiple stain colours, legs available in RAL or steel colours

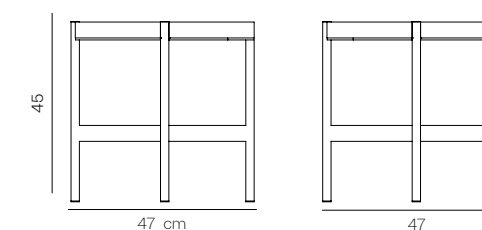

**Dimensions**  
Dia 47 H 45 cm

## London Mid Coffee Table



**Designer** Burcu Özdamar

Top: Wood veneer top available in natural walnut veneer or oak veneer with multiple stain colours  
Leg: Metal or stainless steel legs (with powder coated metal and coloured steel options)  
Finish: Available in multiple stain colours, legs available in RAL or steel colours

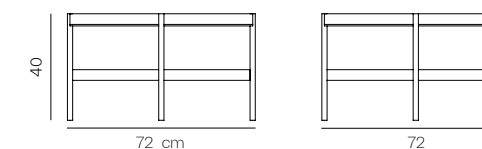

**Dimensions**  
Dia 72 H 40 cm

## London Low Coffee Table



**Designer** Burcu Özdamar

Top: Wood veneer top available in natural walnut veneer or oak veneer with multiple stain colours  
Leg: Metal or stainless steel legs (with powder coated metal and coloured steel options)  
Finish: Available in multiple stain colours, legs available in RAL or steel colours

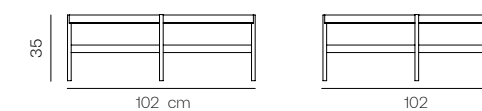

**Dimensions**  
Dia 102 H 35 cm

## Oyster Coffee Table



**Designer** Enis Altinkaynak

Top: Marble top available in Alexander Black, Bruno Perla, Carrara, Emparador Mocca marbles or Travertine Stone  
Leg: Solid ash legs  
Finish: Legs available in multiple stain colours

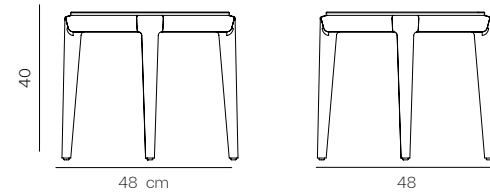

**Dimensions**  
Dia 48 H 40 cm

## Oyster V Coffee Table



**Designer** Enis Altinkaynak

Top: Ash veneer table top  
Leg: Solid ash legs  
Finish: Legs available in multiple stain colours

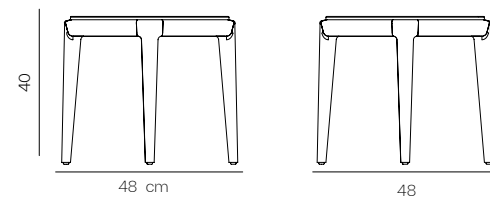

**Dimensions**  
Dia 48 H 40 cm

## Goba Coffee Table



**Designer** Esin Sözen Kalender

Top: Marble top available in Alexander Black, Bruno Perla, Carrara, Emparador Mocca marbles or Travertine Stone  
Leg: Solid beech legs  
Finish: Available in multiple stain colours

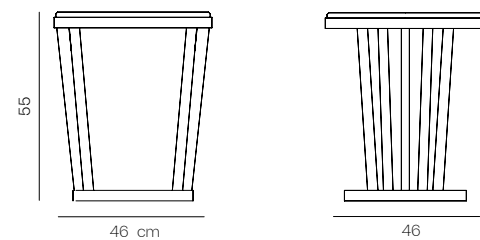

**Dimensions**  
Dia 46 H 55 cm







**Sofas**



## Hug Sofa

**Designer** Betül İnci

Frame: Plywood and solid beech structure, oak wood base  
Seat & Back: Upholstered seat and back  
Finish: Available in multiple stain colours

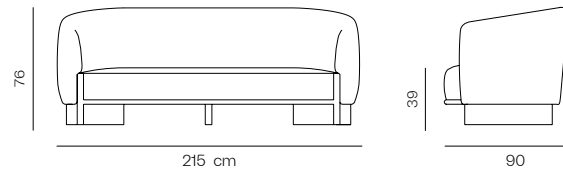

**Dimensions**

W 200 D 83 H 75    Seat height: 38 cm

## London Sofa

**Designer** Burcu Özdamar

Frame: Plywood and solid beech structure, wood veneer base and metal or stainless steel legs (with powder coated metal or coloured steel options)  
Seat & Back: Upholstered seat, back and cushions  
Finish: Base is available in natural walnut or oak veneer with multiple stain colours, legs are available in RAL or steel colours

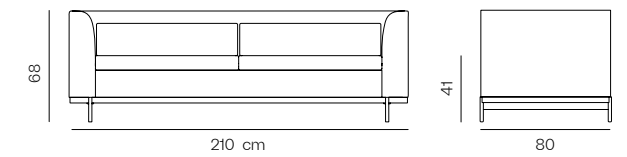

**Dimensions**

W 210 D 80 H 68    Seat height: 41 cm

## Grace Sofa

**Designer** Betül İnci

Frame: Plywood and solid beech structure  
Seat & Back: Upholstered seat, back and cushions

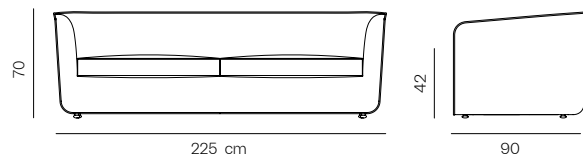

**Dimensions**

W 225 D 90 H 70    Seat height: 42 cm

## Goba Sofa

**Designer** Esin Sözen Kalender

Frame: Solid beech structure  
Seat & Back: Upholstered seat and back cushions  
Finish: Available in multiple stain colours

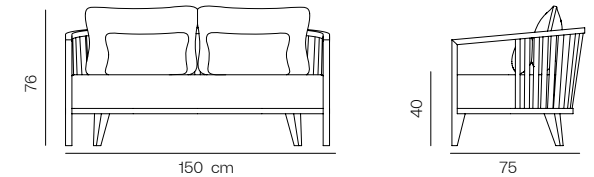

**Dimensions**

W 150 D 75 H 76    Seat height: 40 cm



## Luce Sofa



### Designer Betül İnci

Frame: Plywood and solid beech structure, powder coated metal legs  
Seat & Back: Upholstered seat and back  
Finish: Available in RAL colours

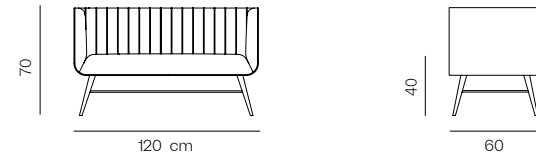

**Dimensions**  
W 120 D 60 H 70    Seat height: 40 cm

## Net Sofa



### Designer Betül İnci

Frame: Plywood and solid beech structure  
Seat & Back: Upholstered seat and inner back, woven banana fiber back  
Finish: Available in multiple stain colours

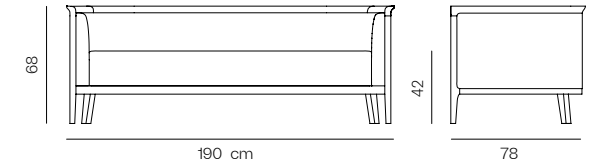

**Dimensions**  
W 190 D 78 H 68    Seat height: 42 cm

## Atlas Sofa



### Designer Betül İnci

Frame: Plywood and solid beech structure, solid beech legs  
Seat & Back: Upholstered seat and back  
Finish: Available in multiple stain colours

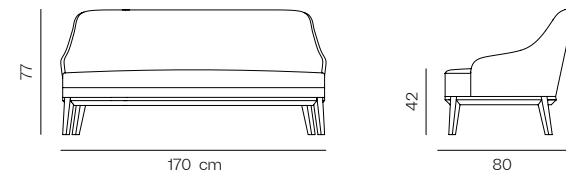

**Dimensions**  
W 170 D 80 H 77    Seat height: 42 cm

## Net WF Sofa



### Designer Betül İnci

Frame: Plywood and solid beech structure  
Seat & Back: Upholstered seat, inner and outer back  
Finish: Available in multiple stain colours

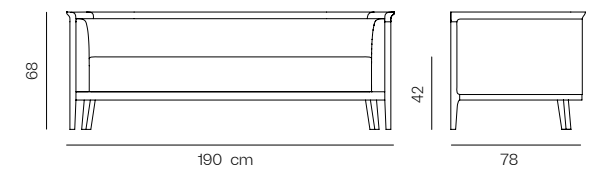

**Dimensions**  
W 190 D 78 H 68    Seat height: 42 cm



## Estival Sofa

Designer Parla Studio

Frame: Plywood and solid beech structure, powder coated metal base  
 Seat & Back: Upholstered seat, back and cushions  
 Finish: Available in RAL colours

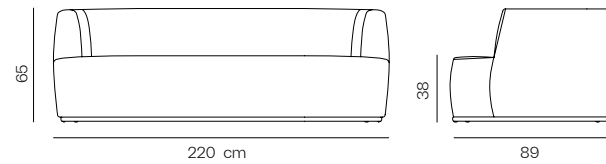

**Dimensions**  
 W 220 D 89 H 65    Seat height: 38 cm

## Estival L Sofa

Designer Parla Studio

Frame: Plywood and solid beech structure, powder coated metal base  
 Seat & Back: Upholstered seat, back and cushions  
 Finish: Available in RAL colours expansion available for Left or Right directions

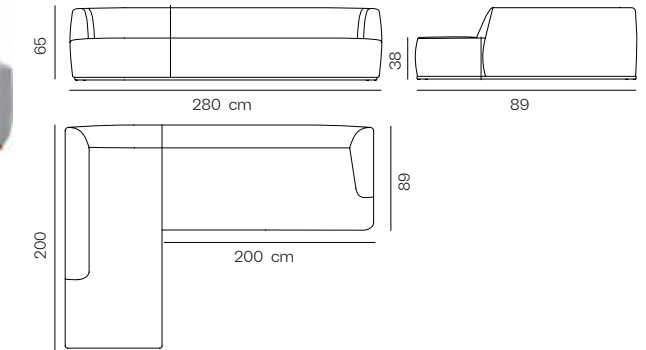

**Dimensions**  
 W 280+200 D 89 H 65    Seat height: 38 cm

## Petra Sofa

Designer Betül İnci

Frame: Plywood and solid beech structure, powder coated metal legs  
 Seat & Back: Upholstered seat and back  
 Finish: Available in RAL colours

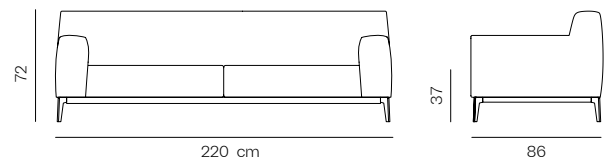

**Dimensions**  
 W 220 D 86 H 72    Seat height: 37 cm

## Petra L Sofa

Designer Betül İnci

Frame: Plywood and solid beech structure, powder coated metal legs  
 Seat & Back: Upholstered seat and back  
 Finish: Available in RAL colours expansion available for Left or Right directions

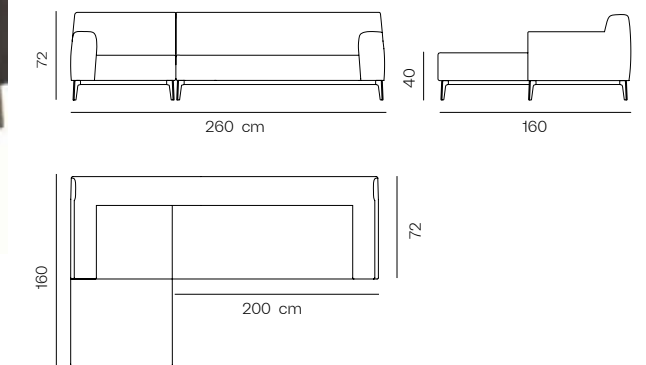

**Dimensions**  
 W 260+160 D 87 H 72    Seat height: 40 cm



**Outdoor**



## Morwi A Chair



**Designer** Berrak İlkcan Şener

Frame: Powder coated metal structure with outdoor treatment, back structure woven with PE rope  
 Seat & Back: Upholstered seat cushion  
 Finish: Frame available in RAL colours, rope is available in Grey white, Antracite Grey, Lemon Verbena and Vermillion Red

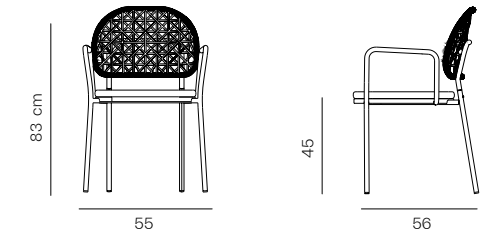

**Dimensions**

**W 55 D 56 H 83**    Seat height: 45 cm

## Morwi Chair



**Designer** Berrak İlkcan Şener

Frame: Powder coated metal structure with outdoor treatment, back woven with PE rope  
 Seat & Back: Upholstered seat cushion  
 Finish: Frame available in RAL colours, rope available in Grey White, Antracite Grey, Lemon Verbena and Vermillion Red

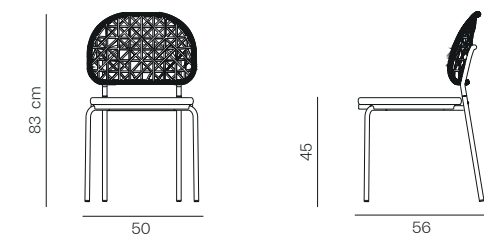

**Dimensions**

**W 50 D 56 H 83**    Seat height: 45 cm

## Iona Chair



### Designer Deniz Albayrak

Frame: Powder coated metal structure with outdoor treatment, back structure woven with polyester rope available in black, tan and khaki rope colours  
Seat & Back: Solid iroko base and PVC seat with upholstered seat cushion  
Finish: Available in RAL colours with outdoor treatment, base available in natural iroko colour

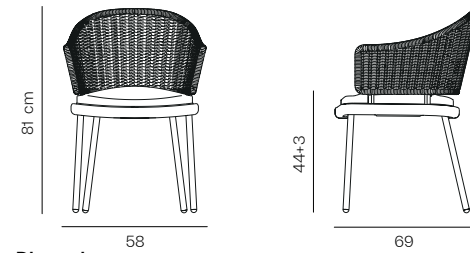

#### Dimensions

W 58 D 69 H 81    Seat height: 44+3 cm cushion

## Tanin Chair



### Designer Erden Dereli

Frame: Powder coated metal structure  
Seat & Back: Solid iroko seat, woven with polyester rope back available in black, tan and khaki rope colours  
Finish: Leg available in RAL colours with outdoor treatment, seat in natural iroko colour

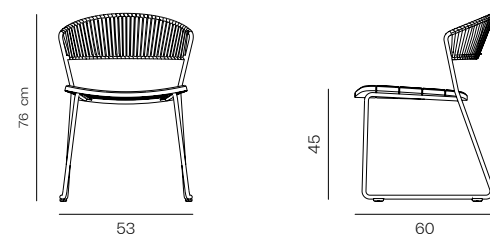

#### Dimensions

W 53 D 60 H 76    Seat height: 45 cm







## Svelte T Chair



**Designer** Umut Karginoğlu

Frame: Solid iroko structure  
 Seat & Back: Upholstered seat and back cushion  
 Finish: Available in natural iroko colour

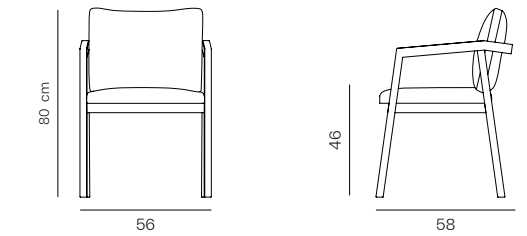

**Dimensions**  
**W 56 D 58 H 80**    Seat height: 46 cm

## Akka Chair



**Designer** Klan Studio

Frame: Powder coated aluminium structure, solid iroko arms and legs  
 Seat & Back: Upholstered seat and back cushions  
 Finish: Available in RAL colours with outdoor treatment, legs and arms available in natural iroko colour

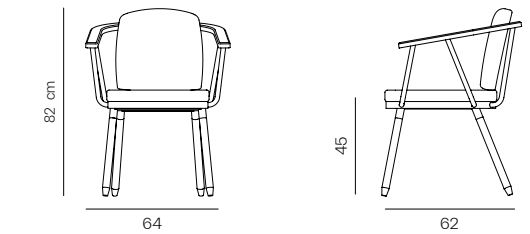

**Dimensions**  
**W 64 D 62 H 82**    Seat height: 45 cm

## Venus XL T Chair



**Designer** Betül İnci

Frame: Solid iroko structure  
 Seat & Back: Upholstered seat and back woven with PE rope  
 Finish: Available in natural iroko colour

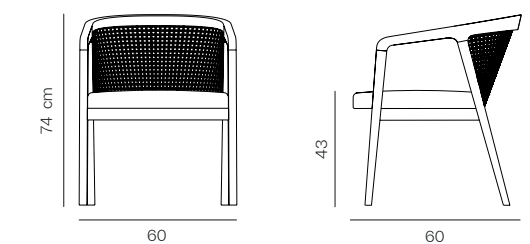

**Dimensions**  
**W 60 D 60 H 74**    Seat height: 43 cm



Four Seasons Hotel Istanbul at Sultanahmet - Istanbul, Turkey

## Chia E Chair



### Designer Betül İnci

Frame: Powder coated aluminium structure, woven back with polyester rope available in black, tan and khaki rope colours  
Seat & Back: Upholstered seat cushion  
Finish: Available in RAL colours with outdoor treatment

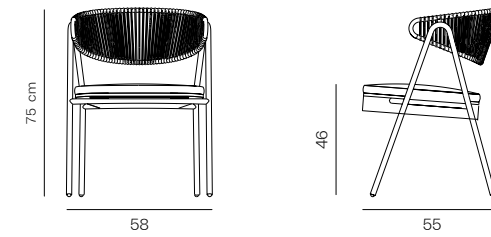

#### Dimensions

W 58 D 55 H 75    Seat height: 46 cm

## Capri Chair



### Designer Betül İnci

Frame: Powder coated aluminium structure woven with polyester rope available in black, tan and khaki rope colours  
Seat & Back: Upholstered seat and back cushion  
Finish: Available in RAL colours with outdoor treatment

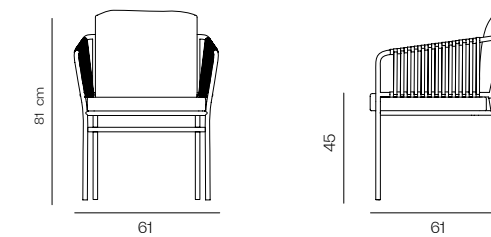

#### Dimensions

W 61 D 61 H 81    Seat height: 45 cm

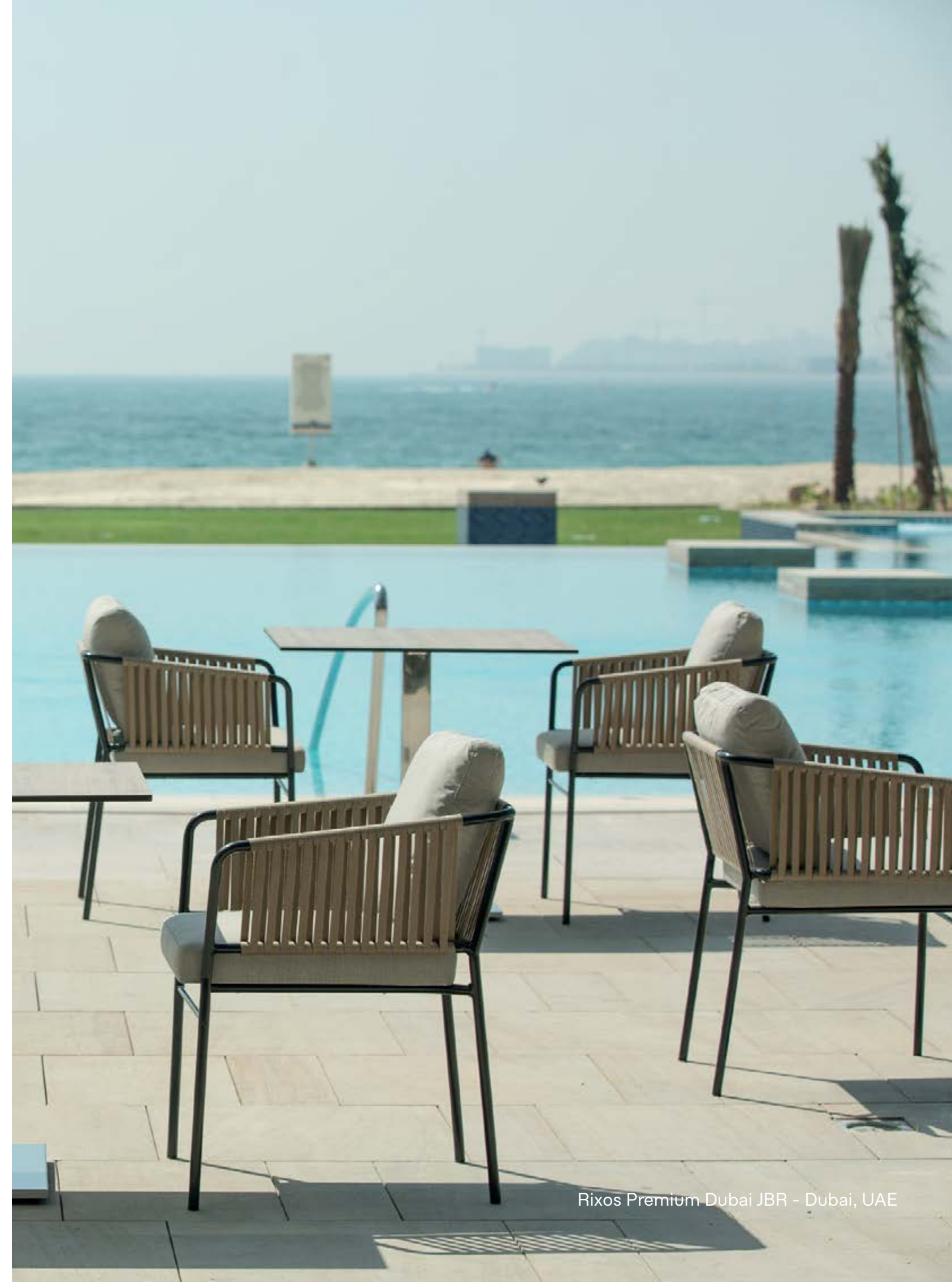

Rixos Premium Dubai JBR - Dubai, UAE

## Capri Lounge Armchair



**Designer** Betül İnci

Frame: Powder coated aluminium structure woven with polyester rope available in black, tan and khaki rope colours  
Seat & Back: Upholstered seat and back cushion  
Finish: Available in RAL colours with outdoor treatment

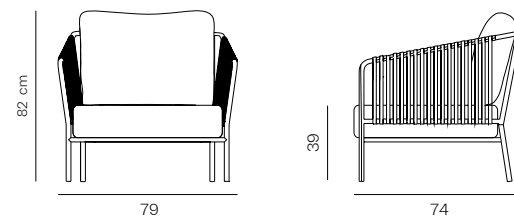

**Dimensions**

W 79 D 74 H 82    Seat height: 39 cm

## Svelte T Armchair



**Designer** Umut Kargınoğlu

Frame: Solid iroko structure  
Seat & Back: Upholstered seat and back cushion  
Finish: Available in natural iroko colour

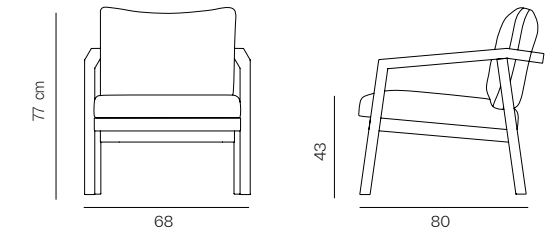

**Dimensions**

W 68 D 80 H 77    Seat height: 43 cm

## Bloom E Club Armchair



**Designer** Betül İnci

Frame: Solid iroko legs and metal structure woven with polyester rope available in black, tan and khaki rope colours  
Seat & Back: Upholstered seat and back cushions  
Finish: Available in natural iroko colour

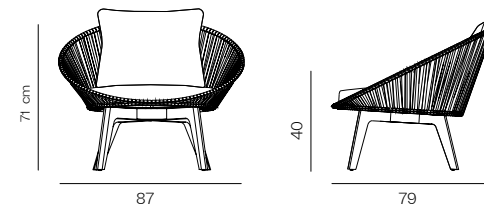

**Dimensions**

W 87 D 79 H 71    Seat height: 40 cm

## Goba T Armchair



**Designer** Esin Sözen Kalender

Frame: Solid iroko structure  
Seat & Back: Upholstered seat and back cushion  
Finish: Available in natural iroko colour

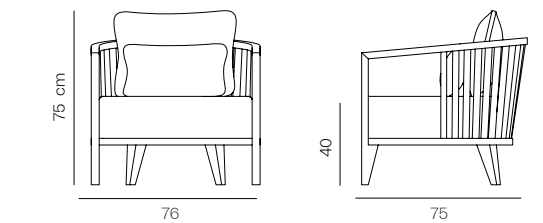

**Dimensions**

W 76 D 75 H 75    Seat height: 40 cm



Pınar Hotel - Balıkesir, Turkey

## Bloom E Bar Stool

**Designer Betül İnci**

Frame: Powder coated metal structure woven with polyester rope available in black, tan and khaki rope colours  
 Seat: Upholstered seat  
 Finish: Available in RAL colours with outdoor treatment  
 \* Available in counterheight

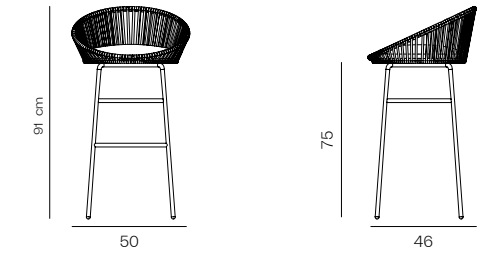

**Dimensions**  
**W 50 D 46 H 91**    Seat height: 75 cm

## Capri Bar Stool

**Designer Betül İnci**

Frame: Powder coated aluminium structure woven with polyester rope available in black, tan and khaki rope colours  
 Seat & Back: Upholstered seat and back cushion  
 Finish: Available in RAL colours with outdoor treatment  
 \* Available in counterheight

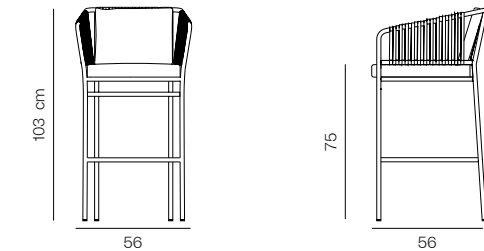

**Dimensions**  
**W 56 D 56 H 103**    Seat height: 75 cm

## Morwi Bar Stool

**Designer Berrak İlkcan Şener**

Frame: Powder coated metal structure with outdoor treatment, back structure woven with PE rope  
 Seat & Back: Upholstered seat cushion  
 Finish: Frame available in RAL colours, rope is available in Grey white, Antracite Grey, Lemon Verbena and Vermillion Red  
 \* Available in counterheight

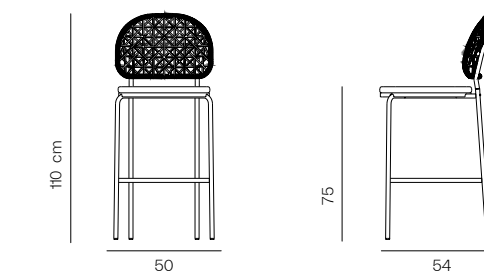

**Dimensions**  
**W 50 D 54 H 110**    Seat height: 75 cm

## Svelte T Sofa



### Designer Umut Kargınoğlu

Frame: Plywood and solid beech structure, natural wood veneer base and powder coated metal or coloured steel leg  
Seat & Back: Upholstered seat, back and cushions  
Base is available in walnut or oak veneer with multiple stain colours, legs are available in RAL colours or coloured steel finishes

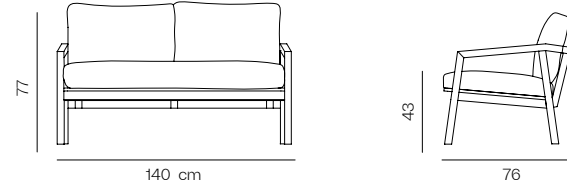

#### Dimensions

W 140 D 76 H 77    Seat height: 43 cm

## Goba T Sofa



### Designer Esin Sözen Kalender

Frame: Solid beech structure  
Seat & Back: Upholstered seat and back cushions  
Finish: Available in multiple stain colours

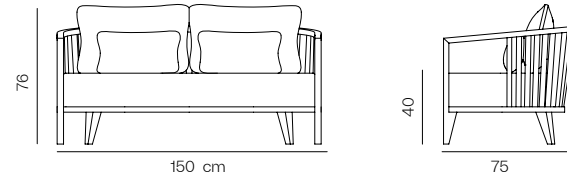

#### Dimensions

W 150 D 75 H 76    Seat height: 40 cm

## Goba T Coffee Table



### Designer Esin Sözen Kalender

Top: Marble top available in Alexander Black, Bruno Perla, Carrara, Emparador Mocca marbles or Travertine Stone  
Leg: Solid iroko  
Finish: Available in natural iroko colour

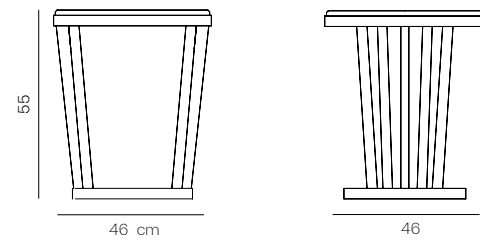

#### Dimensions

Dia 46 H 55 cm





# Storage & Consoles

## Flento Console



**Designer** Berrak İlkcan Şener & Yasemin Derici Çeri

Top: Upholstered genuine leather top  
Frame: Solid ash and coloured stainless steel legs  
Finish: Available in steel colours, legs available in multiple stain colours. Top available in Bitter and Cinnamon

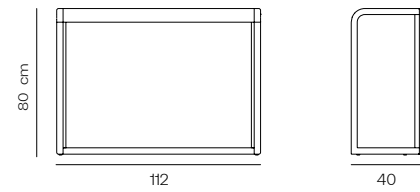

**Dimensions**  
W 112 D 40 H 80 cm

## Rain Small Console



**Designer** Buket Hoşcan Bazman

Body: Oak veneer cabinet with glass doors & metal handle & legs  
Finish: Available in multiple stain colours, legs available in coloured steel colours.

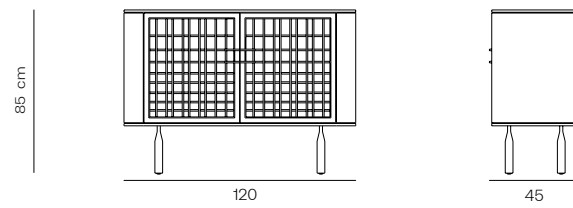

**Dimensions**  
W 120 D 45 H 85 cm

## Rain Console



**Designer** Buket Hoşcan Bazman

Body: Oak veneer cabinet with glass doors and metal handle & legs  
Finish: Available in multiple stain colours, legs available in coloured steel colours

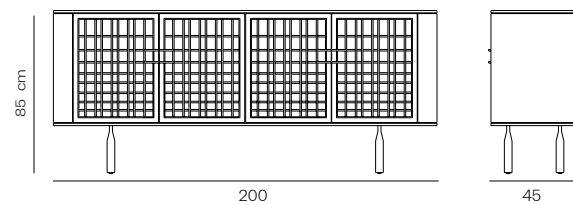

**Dimensions**  
W 200 D 45 H 85 cm







# Product List by Category

# Chairs



Atlas A Chair  
Pg: 45



Atlas Chair  
Pg: 45



Arven Chair  
Pg: 37



Arven L Chair  
Pg: 37



Oyster W Chair  
Pg: 38



Oyster WA Chair  
Pg: 38



Remus Chair  
Pg: 52



Remus S Chair  
Pg: 52



Chia Chair  
Pg: 42



Fau A Chair  
Pg: 29



Gala V Chair  
Pg: 32



Kybele WF Chair  
Pg: 41



Ren Chair  
Pg: 51



Ren P Chair  
Pg: 51



Rimo Chair  
Pg: 42



Sabien A Chair  
Pg: 55



Luna A Chair  
Pg: 52



Mate XL Chair  
Pg: 48



Mate XL V Chair  
Pg: 48



Meru Chair  
Pg: 41



Sabien Chair  
Pg: 55



Stella Chair  
Pg: 56



Stella V Chair  
Pg: 56



Stella W Chair  
Pg: 56



Meru L Chair  
Pg: 41



Mod Chair  
Pg: 55



Mod S Chair  
Pg: 61



Mod RS Chair  
Pg: 61



Venus A Chair  
Pg: 32



Venus Chair  
Pg: 32



Mod W Chair  
Pg: 61



Nigiri Chair  
Pg: 29



Olive Chair  
Pg: 45



Oyster Chair  
Pg: 38

# Armchairs



Atlas Armchair  
Pg: 70



Atlas V Armchair  
Pg: 70



Bloom Club Armchair  
Pg: 75



Estival Armchair  
Pg: 79



Eve Wing Back Armchair  
Pg: 69



Goba Armchair  
Pg: 76



Hug Armchair  
Pg: 65



Luce Armchair  
Pg: 79



Milla Armchair  
Pg: 79



Moose Armchair  
Pg: 65



Net Armchair  
Pg: 65



Net WF Armchair  
Pg: 76



Oyster W Armchair  
Pg: 66



Padova Armchair  
Pg: 75



Padova U Armchair  
Pg: 75



Remus Armchair  
Pg: 70



Rimo Armchair  
Pg: 66



Xaylon W Armchair  
Pg: 69



Xaylon Armchair  
Pg: 69

# Coffee Tables



Blossom Coffee Table  
Pg: 112



Bone Coffee Table  
Pg: 118



Bone Mid Coffee Table  
Pg: 118



Fliento Side Table  
Pg: 117



Goba Coffee Table  
Pg: 120



Jane M Coffee Table  
Pg: 115



London High Coffee Table  
Pg: 119



London Low Coffee Table  
Pg: 119



London Mid Coffee Table  
Pg: 119



Mandala Coffee Table  
Pg: 114



Mandala M Coffee Table  
Pg: 114



Mandala V Coffee Table  
Pg: 114



Mawe Coffee Table  
Pg: 117



Mawe Low Coffee Table  
Pg: 117



Miller Coffee Table  
Pg: 115



Oyster Coffee Table  
Pg: 120



Oyster V Coffee Table  
Pg: 120



Platy Coffee Table  
Pg: 115



Tofu Coffee Table  
Pg: 112



Tofu V Coffee Table  
Pg: 112

# Bar Stools



Arven Bar Stool  
Pg: 90



Arven L Bar Stool  
Pg: 90



Bloom Bar Stool  
Pg: 101



Bloom WA Bar Stool  
Pg: 101



Chia Bar Stool  
Pg: 96



Flento Bar Stool  
Pg: 96



Luce Bar Stool  
Pg: 96



Mate Bar Stool  
Pg: 100



Mate V Bar Stool  
Pg: 100



Meru Bar Stool  
Pg: 95



Meru L Bar Stool  
Pg: 95



Nigiri Bar Stool  
Pg: 89



Oyster Bar Stool  
Pg: 89



Sabien Bar Stool  
Pg: 99



Stella Bar Stool  
Pg: 99



Venus Bar Stool  
Pg: 99

# Stools & Poufs



Atlas Pouf  
Pg: 82



London Pouf  
Pg: 82



Luce Foot Stool  
Pg: 83



Luce Stool  
Pg: 83



Remus Pouf  
Pg: 82



Rocks Pouf  
Pg: 83

# Tables



Roll B Table  
Pg: 107



Tofu V Table  
Pg: 106



Tofu Table  
Pg: 106



Tria Table  
Pg: 107

# Sofas



Atlas Sofa  
Pg: 130



Estival Sofa  
Pg: 134



Estival L Sofa  
Pg: 135



Goba Sofa  
Pg: 127



Grace Sofa  
Pg: 126



Hug Sofa  
Pg: 126



London Sofa  
Pg: 127



Luce Sofa  
Pg: 130



Net Sofa  
Pg: 131



Net WF Sofa  
Pg: 131



Petra Sofa  
Pg: 134



Petra L Sofa  
Pg: 135

# Storage & Consoles



Flento Console  
Pg: 156



Rain Console  
Pg: 156



Rain Small Console  
Pg: 156

# Outdoor



Akka Chair  
Pg: 143



Capri Chair  
Pg: 146



Chia E Chair  
Pg: 146



Iona Chair  
Pg: 140



Morwi A Chair  
Pg: 139



Morwi Chair  
Pg: 139



Svelte Chair  
Pg: 143



Tanin Chair  
Pg: 140



Venus XL T Chair  
Pg: 143



Bloom E Bar Stool  
Pg: 151



Capri Bar Stool  
Pg: 151



Morwi Bar Stool  
Pg: 151



Bloom E Club Armchair  
Pg: 148



Capri Armchair  
Pg: 148



Goba T Armchair  
Pg: 149



Svelte T Armchair  
Pg: 149



Goba T Sofa  
Pg: 152



Svelte T Sofa  
Pg: 152



Goba T Coffee Table  
Pg: 152



# Materials & Colours

## Solid Wood

### Ash

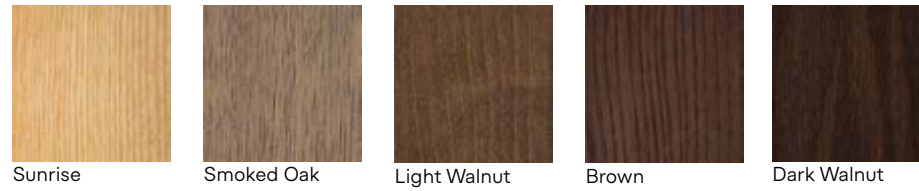

### Beech

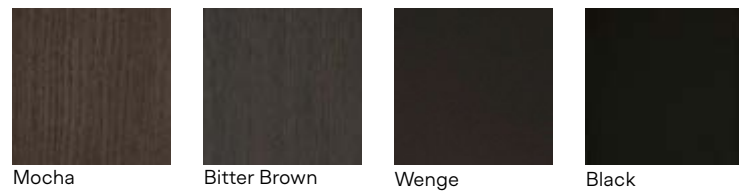

## Wood Veneer

### Oak

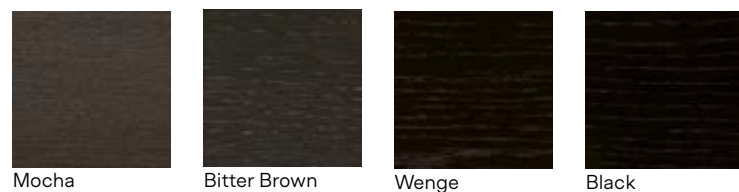
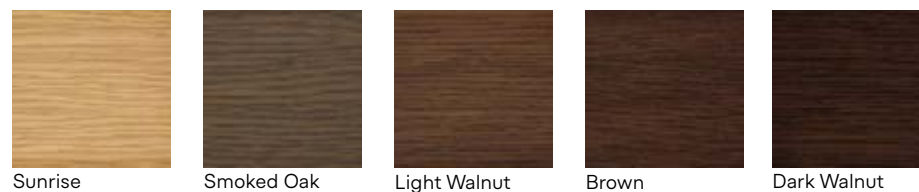

### American Walnut

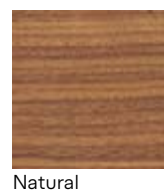

\*We use quarter cut veneer sheets with slip matching on plywood as our standard for wood veneer options.

## Metal

### Brass

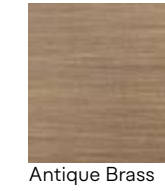

### Powder Coated Matte



### Coloured Steel



\* This finish requires an additional 2 weeks for production.

## Glass & Stone

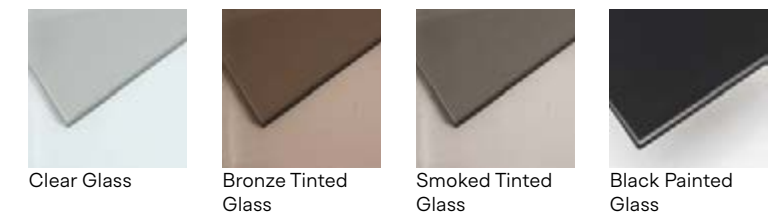
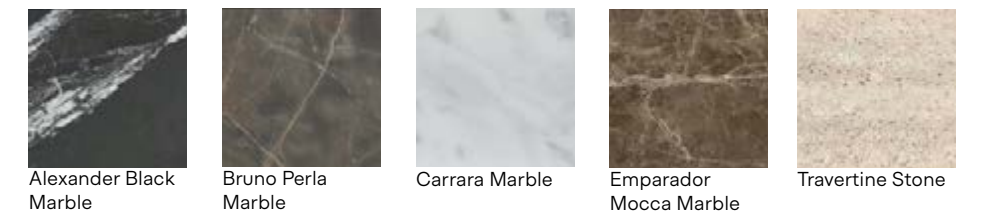

## Outdoor

### Iroko



Natural\*

\* Direct exposure to sunlight will eventually affect Iroko's colour, creating a darker shade in time.

### Powder Coated Textured



Oyster White Textured 1013



Grey White Textured 9002

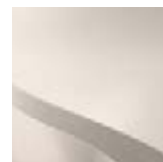

Pure White Textured 9010



Grey Beige Textured 1019



Peanut Textured 967

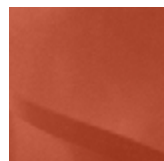

Salmon Orange Textured 2012

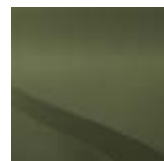

Reed Green Textured 6013



Earth Textured 39

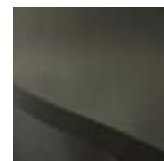

Stone Grey Textured 7030

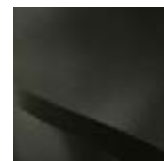

Umbr Grey Textured 7022

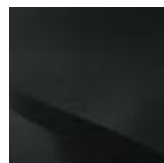

Black Grey Textured 7021

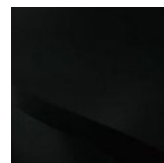

Jet Black Textured 9005

### Rope

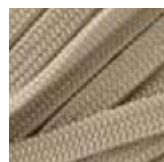

Flat Rope Tan

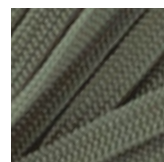

Flat Rope Khaki



Flat Rope Black



Woven Rope Tan

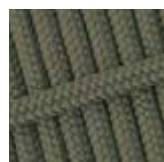

Woven Rope Khaki

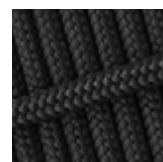

Woven Rope Black



Grey White GR10



Lemon Verbena K10

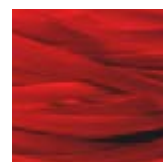

Vermilion TR17



Anthracite Grey GR23

## Upholstery / Fabric

### Category A

#### Athena

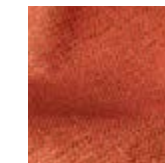

1131



1144

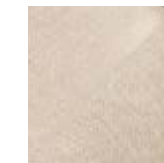

1152



1158



1192



1203



1209

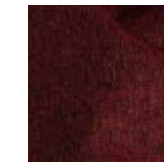

1212

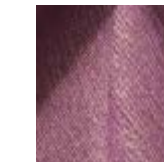

1215

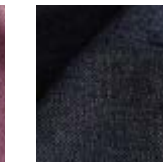

1225



1230

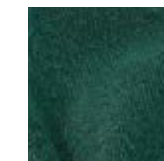

1238

### Category A

#### Velluto

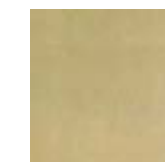

K18010

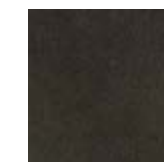

K180J3

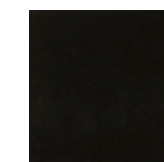

K1848

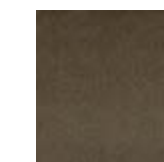

K180T8

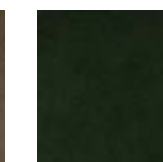

K180BM

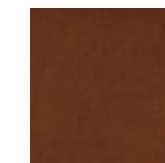

K1821

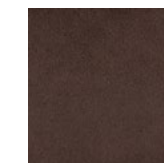

K180R7

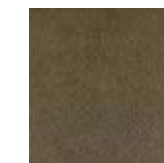

K180N9

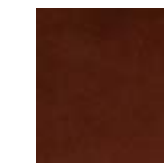

K180K7

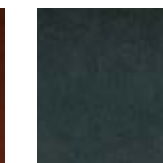

K180E2

### Category B

#### Aspect

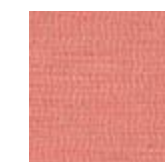

ACT07

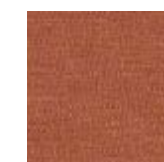

ACT08

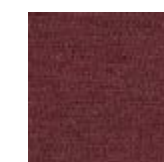

ACT09



ACT12



ACT14

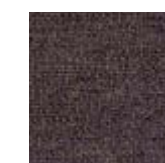

ACT15

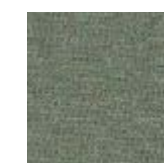

ACT17

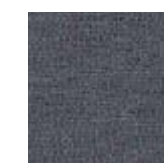

ACT29

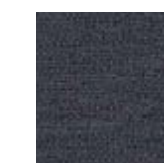

ACT30



ACT31



## Category B

Magician

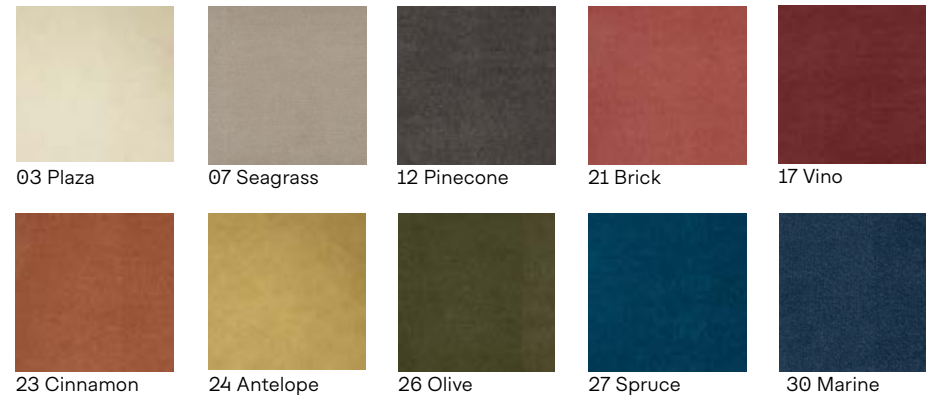

## Category B

Winston

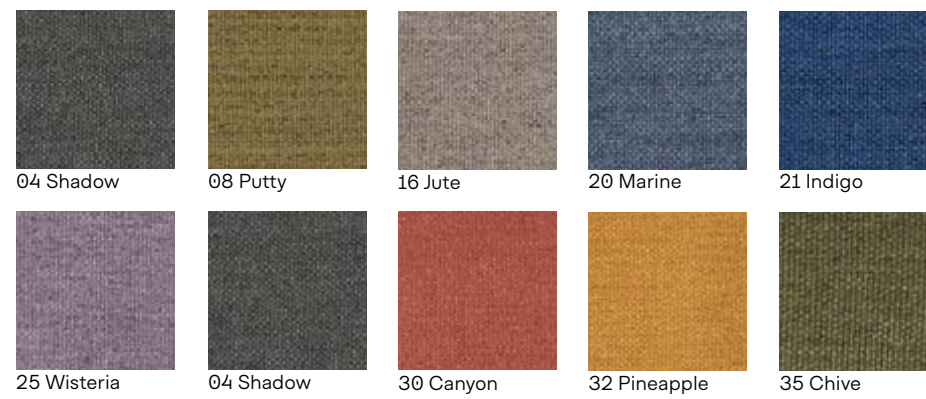

## Category B

Teddy

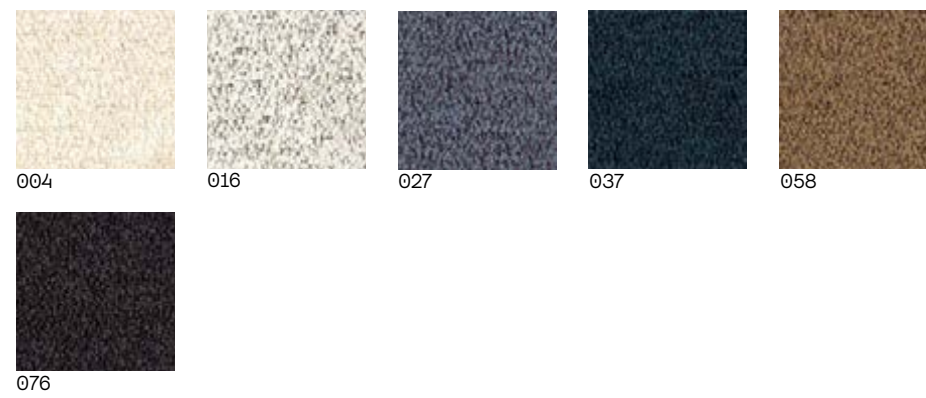

## Category B

Rizo



## Category B

Nino

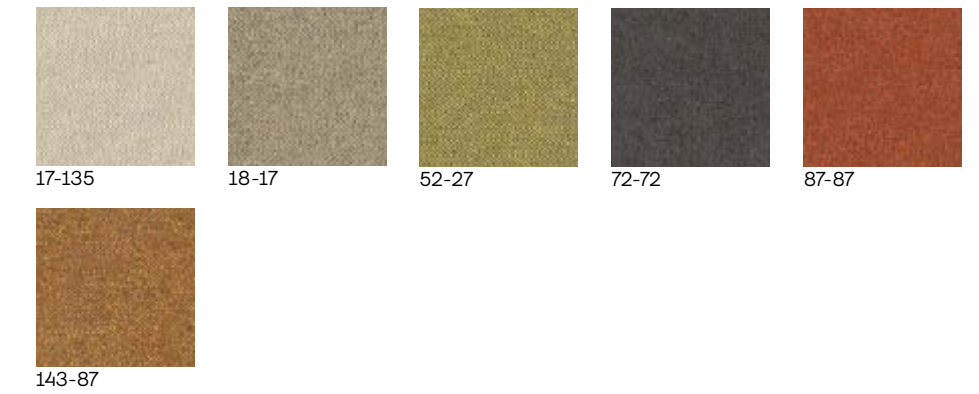

## Category B

New Sabine



## Category C

Main Line Flax

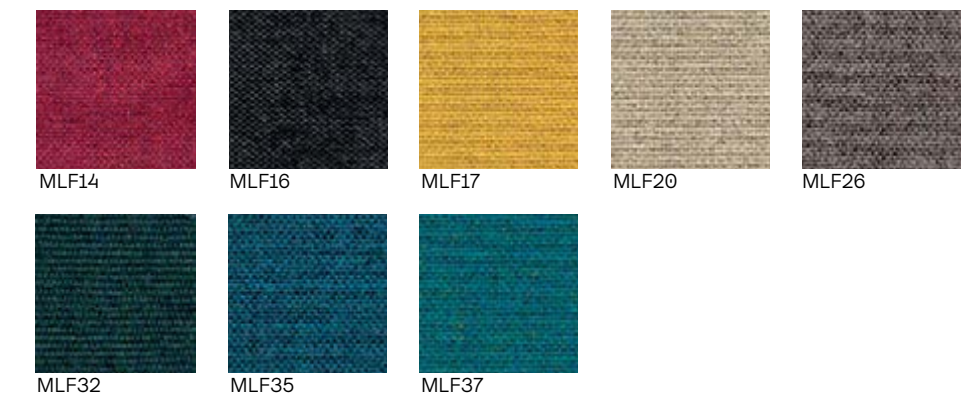

## Category C

Loft



## Category C

Bolt

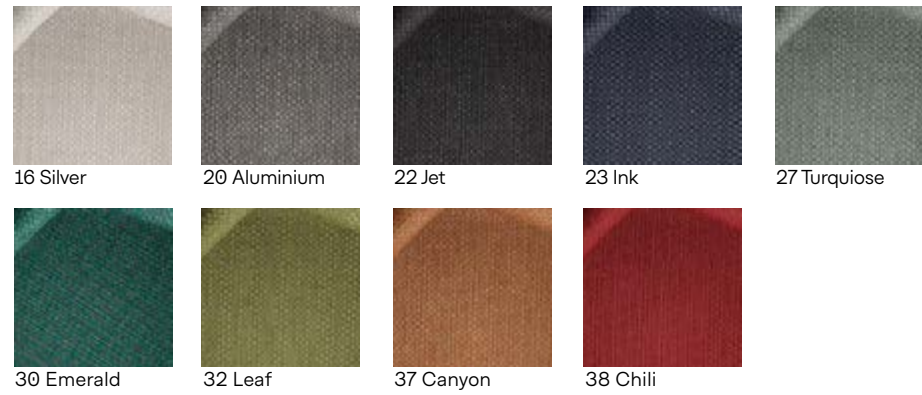

## Category D

Remix 3

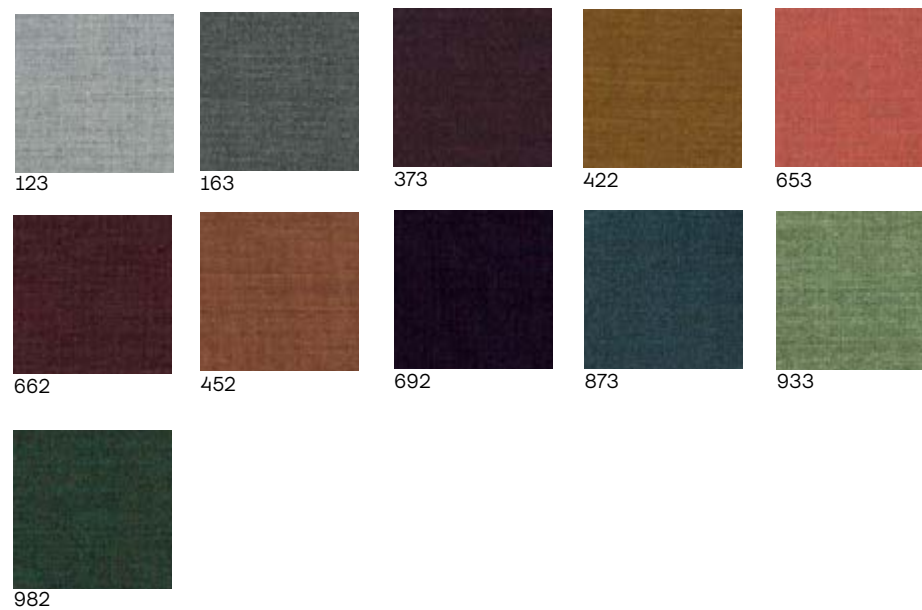

## Category E

Steelcut Trio

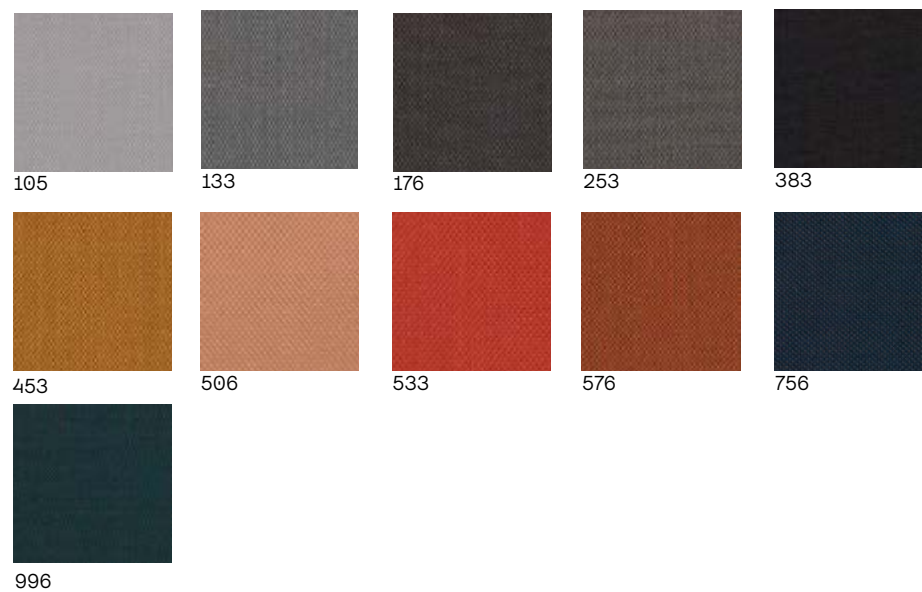

## Category E

Hallingdal 65

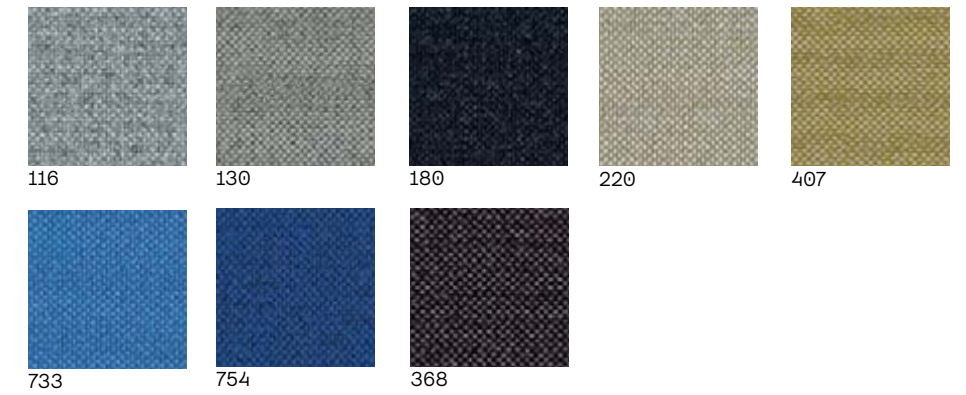

## Upholstery / Outdoor

### Category A

Malta 02

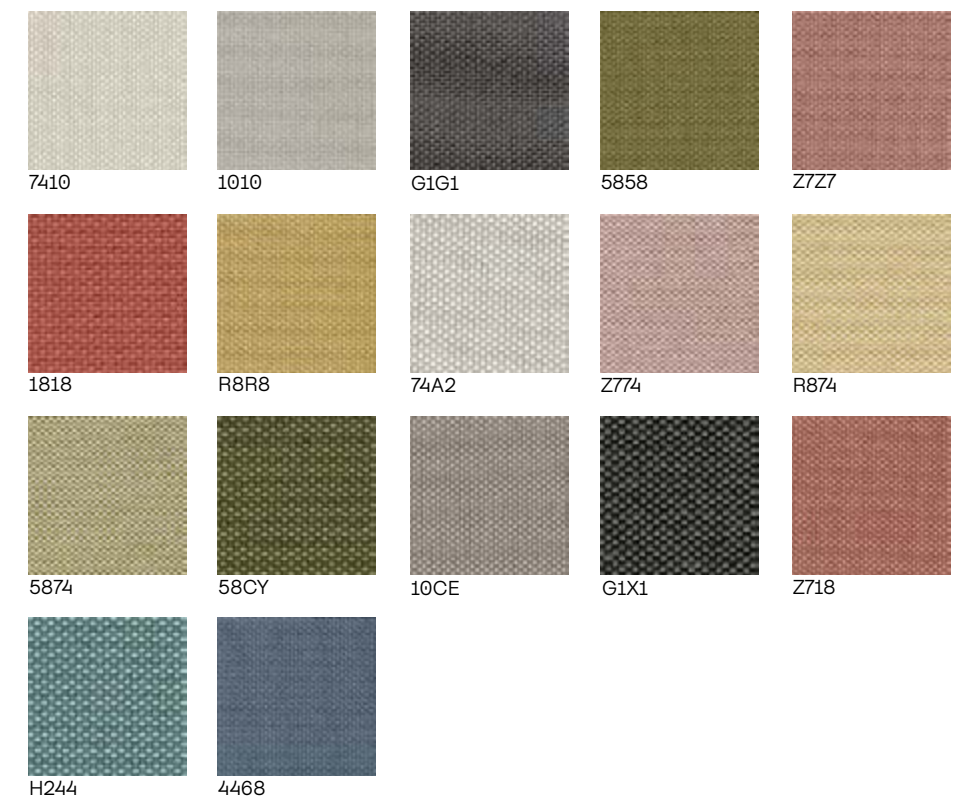

## Category C

P Heritage



## Category D

S Heritage



## Category D

Patio

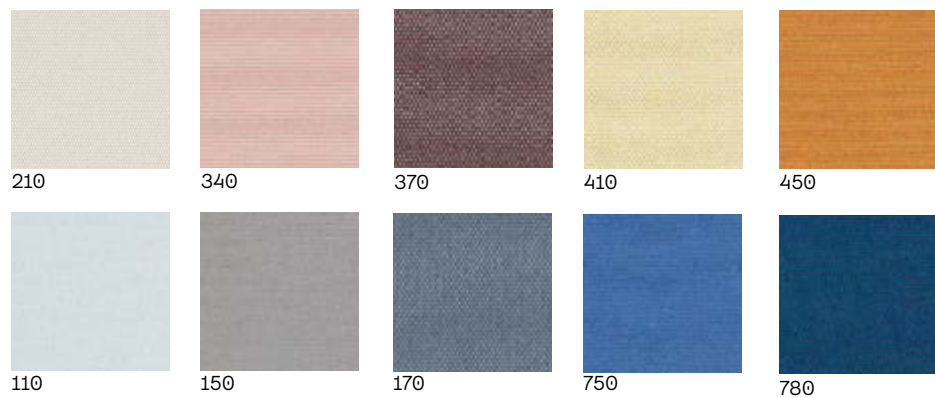

## Upholstery / Artificial Leather

### Category A

Nona FR

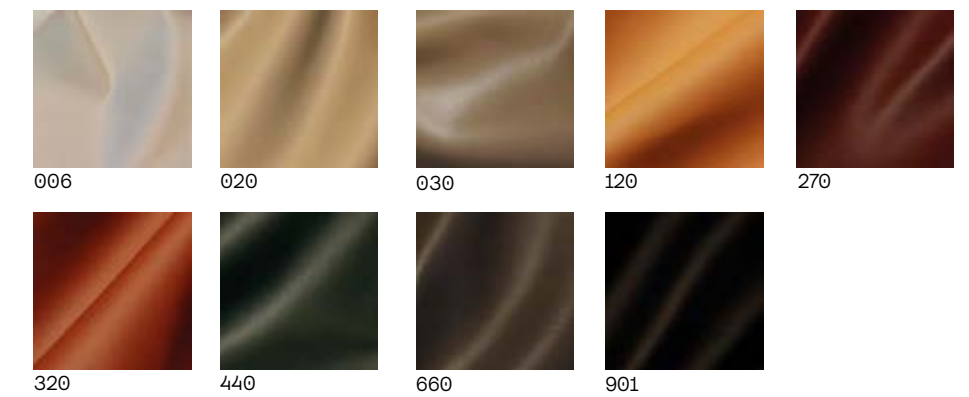

### Category B

Best FR

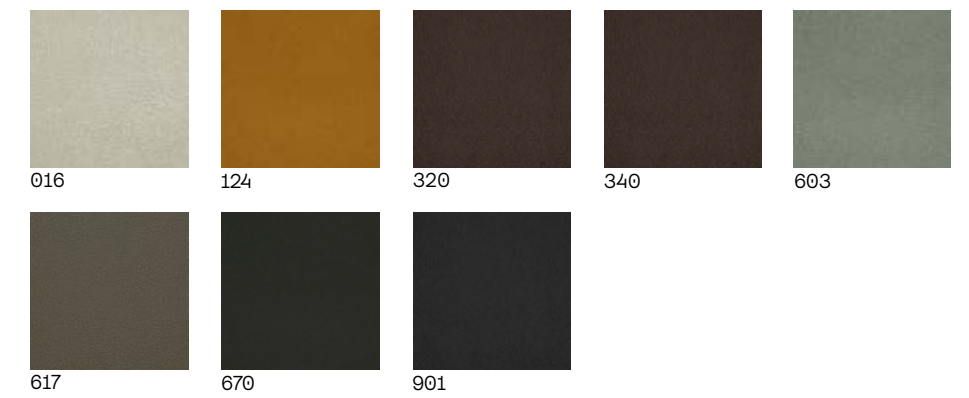

### Category C

Vita



## Upholstery / Genuine Leather

### Category L1

Antik



## Category L1

Relax



## Category L2

Lena



## Category L2

Etna

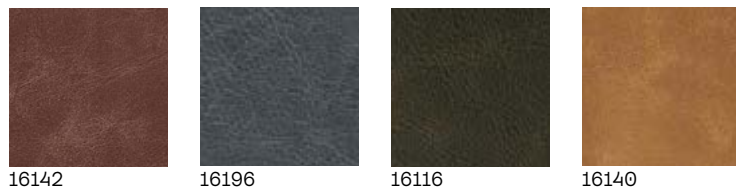

## Category L2

Fantasy



## Category L2

Anatolia



## Guide for Care & Maintenance

Thank you for choosing Parla.

Our mission is to manufacture products that meet the highest standards in design, quality and functionality.

Regular professional care extends the life time of each product and thus also your satisfaction with its use. You can find some useful information on how to use and carefully maintain our products below.

### SOLID WOOD INDOOR USE

The Solid wood we use is an actual living part of the tree it comes from, and is composed of wood fibers that are held together with adhesives.

At Parla, our most popular choice of solid wood is Beech, and what we do is create pieces of lumber that have their own characteristics; unique in grain pattern, colour, and texture. As a result each piece of solid wood displays different behaviour and form when different carving techniques are used. Unlike wood veneer, solid wood pieces are frequently used for curved and multi-dimensional pieces.

### ASH

With a neutral colorbase, ash trees are very durable and robust. Ash also has better resistance to sunlight and its possible corruptive effects.

### BEECH

Having a light-pink undertone, beech wood is very easy to form, therefore easy to use for curved shapes and round corners requiring further surface processing. Parla Collection products are generally produced using Beech wood.

### RECOMMENDATIONS

We recommend cleaning the surface regularly with a slightly damp soft cloth. Do not use heavy chemicals for cleaning purposes and protect the surface from sharp objects to avoid scratching.

\*As wood is a living material, variations in colour, pattern, and pigmentation will occur on each piece.

\*Wooden furniture will also change appearance over time as it is affected by

the environment (daylight, humidity, etc.) in which it is placed.

\*Solid wood furniture should not be placed too close to heat sources nor should it be in frequent contact with liquids.

\*Do not use abrasive materials.

### WOOD VENEER INDOOR USE

A veneer refers to a thin layer of wood peeled or cut from a section of a tree. It is then bonded onto a thick piece of wood, typically MDF, chipboard, or plywood. These layers are classified later according to their cutting technique and final patterns. At Parla, we use quarter cut veneer sheets with slip matching on plywood as standard. Each veneer table layer is unique. No matter how expertly cut or treated, none of its layers are identical to another, which is the charm of using natural materials. Veneer provides high-quality looks without the need for large amounts of wood consumption.

### OAK

A somewhat brittle material when processed, oak is very resistant to heavy weather conditions and harsh climates as a tree. Being a durable and robust form, oak pieces require expertise and unique production techniques.

### WALNUT

A tree familiar with mild climates, the walnut tree has high fibers resulting in splendid and rich patterns on its layers. Easy to process, walnut has high aesthetic qualities however it requires suitable methods to bring out its beauty and strength.

### RECOMMENDATIONS

We recommend cleaning the surface

regularly with a slightly damp soft cloth. Please wipe the veneer following the direction of the wood grain. Compared to solid wood, wood veneer is less resistant to heat and moisture, especially around the edges where layers of wood are visibly pressed. Extreme heat and any contact to water must be avoided, especially around the edges.

\*Veneers generally have color differences compared to their matching solid wood stain options. Which are usually used for chair legs or supportive elements. We, therefore, especially recommend using wood veneer material for stained table tops and legs.

\*Do not use oil or ammonia-based products to clean wood veneer.

\*Do not use abrasive materials.

### METAL INDOOR USE

Metal, brass, aluminium, and stainless steel are the most preferred materials at Parla for the metal components of furniture we produce. Depending on the product type and place of use, metal surfaces are available in Powder Coated Textured (outdoor) or Matte (indoor) or PVD Coated; Polished or Brushed (indoor) finishes.

### STAINLESS STEEL

Durable and more accessible, stainless steel is perfect for structural elements and metallic finishes. PVD coating can be used with different finishes, as shown in our coloured steel options.

## METAL & ALUMINIUM

Parla recommends Powder Coated metal in matte finish for indoor use and aluminium or treated metal in textured finish for outdoor use. Aluminium is a rust-resistant and light material that can be used directly with powder coating without further treatments. However, we recommend using powder coated aluminium with a textured finish to increase the hold of coatings that protect the metal from heavy conditions of outdoor use.

Metal materials on the other hand need to be pre-coated with cataphoresis treatment before coating for protection over rust and corrosion.

## RECOMMENDATIONS

We recommend cleaning the surface with a damp cloth and wiping the surface immediately after.

\*Do not use alcohol.

\*Avoid using abrasive materials that can alter or scratch the surface.

\*For PVD coatings, Parla uses an environmentally friendly Anti Fingerprint solution. Creating a protective layer over stainless steel, this solution creates an easy-to-clean surface, reducing fingerprints.

\*It is not recommended to use PVD Coated steel under direct sunlight for extended periods since it can affect the coating colour over time.

## GLASS & STONE

### GLASS

Characteristic results of glass manufacturing such as tiny air bubbles, thickness variations and light pitting, should always be expected with glass. All glass used in our furniture is tempered to ensure excellent durability. For painted glass, all RAL colour options are available and the final finish is tempered extra clear glass with colour.

### MARBLE & STONE

Travertine Stone and marble are natural and porous materials of sedimentary origin. They are usually collected as stone blocks which are later cut into layers of

stone using a delicate process. The texture of these stones depends on grains. The formed and pressured element groups to create mesmerising grains and layers makes each piece unique. The density of these element groups determines the colour and patterns of the stone.

Before using them as furniture parts stones are treated with an invisible solvent-based chemical to sustain their surface integrity. It penetrates stone pores and protects their surface against dirt, dust, water or stains, generating an easy clean effect. Due to its porous nature this treatment must be applied every few months to help the surface reach its entire service life.

## RECOMMENDATIONS

We recommend carefully cleaning the surface with a barely damp soft cloth to avoid scratching the surface.

Marble is porous and has a poor resistance to acidic substances (vinegar, lemon juice, wine, tea, coffee, etc.) that even in small quantities can corrode the surface and penetrate into the pores forming spots.

\*Do not use any products containing acetone ammonia, chlorine, solvents, abrasive products and furniture polish, since these might permanently damage the surface of the product making it look opaque with marks.

Glass is not scratch-resistant so avoid dragging objects across the surface. Glass is very resistant to heat sources. Still we recommend never placing hot objects directly on the surface since high temperature differences create fragile spots on the surface which, could result in cracks.

\*Glass surfaces should be wiped with a clean dry cloth. Cleaning can be done with household ammonia or unique glass cleaning products if the occasion requires it.

\*Never use abrasives or sharp -edged tools to prevent scratching.

## OUTDOOR

Outdoor furniture needs resistance to heavy weather conditions and direct sunlight. Our experience over time recommends specific types of materials for outdoor furniture, such as Iroko wood, woven ropes, and powder coated textured metal structures.

### SOLID WOOD

#### OUTDOOR USE - IROKO

Iroko is a particular type of timber that grows in rainforest weather conditions, making it highly durable for outdoor use. With its high density of fibers, Iroko can extract minerals and particles from the soil. Because of these features, Iroko grows much faster than traditional timber types and can be produced in a fast-paced sustainable cycle.

Iroko also showcases its stain colors distinctively due to its unique, light yellow based color.

### METAL & ALUMINIUM

#### OUTDOOR USE

Since it is rust-proof, we use powder coated aluminium or pre-treated and powder coated metal structures for outdoor furniture.

For outdoor use, we recommend powder coated metals with a textured finish, pre-coated with cataphoresis treatment to increase the paint's grip and protect the metal from heavy conditions of outdoor use.

For aluminium, powder coating can be applied directly.

### ROPES

The weaving technique and rope options create a vast playground for furniture designers. With round and flat options, hand woven ropes are carefully placed according to templates by professionals constructed by very skilled craftsmen. Woven from pre-UV treated strands, outdoor ropes also have a multi-layered internal structure, making them highly resistant to tension, colour fade and heavy weather conditions.

## RECOMMENDATIONS

We recommend cleaning the Iroko surface regularly with a slightly damp soft cloth.

\*Do not use heavy chemicals for cleaning purposes and protect the surface from sharp objects to avoid scratching.

\*Although they can be in touch with it, outdoor furniture mustn't be in direct contact with salt water for long periods of time since it can cause corrosion. Also, direct exposure to sunlight for extended periods will eventually affect Iroko's colour.

\*Do not use any chemicals for cleaning powder coated metal, clean with damp cloths or water.

\*For extreme weather conditions, UV treatment types for outdoor ropes may vary. Please specify area of use to select the suitable treatment type.

## UPHOLSTERY

### GENUINE LEATHER

Natural leather has a pleasant characteristic smell and is wear resistant. Its quality depends on the animal's lifestyle as well as on the method of leather processing. Minor defects originating during the animal's life, such as wrinkles, blood veins, scars, scratches, etc. are regarded as permissible and are even required as evidence of the 'genuine and unique' quality of the leather.

## RECOMMENDATIONS

The best maintenance for leather is regular vacuuming with a soft brush. Avoid using cleaning products and sharp objects. If cleaning is necessary use boiled water with natural soap shavings of good quality. Whip 2-3 tablespoons of soap flakes in 1-liter water and only use the foam. Apply the foam with a soft cloth, let the furniture dry and dry afterward the leather off thoroughly with a soft cotton cloth.

### ARTIFICIAL LEATHER

Artificial leather is usually undemanding in maintenance.

## RECOMMENDATIONS

Remove dust regularly with a fine suction force of your vacuum cleaner or with a wet cotton cloth.

\*Dry spilled liquids immediately by a dry cotton or paper towel.

\*Do not let other stains dry on the surface but remove them immediately with lukewarm water.

\*Wipe the surface carefully with a moistened cotton cloth and dry with a dry towel.

### FABRIC

Cleaning and maintaining upholstered furniture regularly is important to retain the appearance of the fabric and to prolong its lifespan. Over time, dust and dirt can cause furnishing fabrics to change color and exacerbate wear.

## RECOMMENDATIONS

Vacuum the furniture regularly using the upholstery nozzle to remove dust and avoid fluff and pilling. Straighten the fabric with your hands from time to time. Wrinkles in the fabric can be straightened using a steamer. Soak up spilled liquids immediately with an absorbent napkin or cloth by dabbing gently towards the centre of the stain.

\*Never use concentrated detergents or bleach, ammonia, optical brighteners or soap intended for hard surfaces.

\*We do not recommend spot cleaning of individual marks and stains as this damages the fabric and causes colour loss.

\*Avoid rubbing the material hard as this could result in loss of colour and damage the fabric.

## We kindly ask you to follow instructions and recommendations contained in this manual.

Regular professional care extends the life of your product and besides can be also a condition for warranty compensations. The manufacturer does not take any responsibility for potential damage to the product resulting from unauthorised use and unprofessional handling of the furniture.

Parla is constantly working on further development of all products, which may cause some changes in used materials, constructions and finishing.

As a result of this the recommendations and guidelines for the proper use of products may be also changed. Thank you for your understanding and we wish you pleasant moments spent while using our products.

*\*The products displayed in this catalogue are to be considered as sample configurations. The textures, colors of materials, and finishes are indicative due to variations that may result from the printing process.*

*For any technical specifications and/or dimensions, please get in contact with our sales team. Parla Design reserves the right to change, without prior notice, materials, covers, finishes, and drawings presented in this catalogue.*

parladesign.com



**Istanbul Office / Showroom**

Bareli İş Merkezi, Ayazmadere Cad.  
Pazar Sok. No: 2-4  
Beşiktaş 34349 - Istanbul, TURKEY  
P +90 (212) 216 61 63 / 64

**Istanbul Factory**

Boğazköy Atatürk Mah.  
Yıldırım Beyazıt Cad. No: 194  
Arnavutköy 34285 - Istanbul, TURKEY  
P +90 (212) 685 01 42  
[info@parladesign.com](mailto:info@parladesign.com)

**London Office**

4/4A Bloomsbury Square,  
WC1A2RP - London, UK  
P +44 (0) 20 3865 7703  
[london@parladesign.com](mailto:london@parladesign.com)

**Dubai Office**

Office No: 1509, Sobha Sapphire Bldg  
P.O Box: 123377  
Business Bay - Dubai, UAE  
P +971 4 553 07 28  
[dubai@parladesign.com](mailto:dubai@parladesign.com)

**US Office**

3445 Rankin Street #3445  
Dallas, TX 75205 - USA  
P +1 214 577 6070  
[usa@parladesign.com](mailto:usa@parladesign.com)

parladesign.com

**THE IMPRINT**

Creative Agency: Muhabbet  
Art Direction: Gözde Ulusoy  
Photography: Engin Yıldız, Burak  
Teoman, Tahir Akkurt

©2023 Parla

*All rights reserved. No part of this  
publication may be reproduced, stored  
in a retrieval system or transmitted in  
any form or by any means, electronical,  
mechanical, photocopying, recording or  
otherwise; without the prior permission  
of the copyright owner.*



CPD  
PROVIDER

Ask for our FSC®-certified products

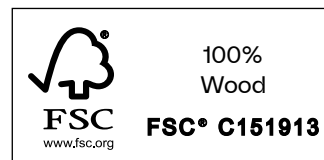

New York / London / Istanbul / Dubai

[www.parladesign.com](http://www.parladesign.com)